

Principles of AI Planning

8. Planning as search: relaxation heuristics

Albert-Ludwigs-Universität Freiburg



Bernhard Nebel and Robert Mattmüller

November 19th, 2014

1 Parallel plans



- Plan steps, serializations and parallel plans
- Forward states and parallel forward distances

- Parallel plans
- Plan steps
- Forward distances
- Relaxed planning graphs
- Relaxation heuristics
- Summary

November 19th, 2014

B. Nebel, R. Mattmüller – AI Planning

3 / 62

Towards better relaxed plans



Why does the greedy algorithm compute low-quality plans?

- It may apply many operators which are not **goal-directed**.

How can this problem be fixed?

- **Reaching the goal** of a relaxed planning task is most easily achieved with **forward search**.
- Analyzing **relevance** of an operator for achieving a goal (or subgoal) is most easily achieved with **backward search**.

Idea: Use a **forward-backward** algorithm that first finds a path to the goal greedily, then prunes it to a relevant subplan.

- Parallel plans
- Plan steps
- Forward distances
- Relaxed planning graphs
- Relaxation heuristics
- Summary

November 19th, 2014

B. Nebel, R. Mattmüller – AI Planning

4 / 62

Relaxed plan steps



How to decide which operators to apply in forward direction?

- We **avoid** such a decision by applying all applicable operators **simultaneously**.

Definition (plan step)

A **plan step** is a set of operators $\omega = \{\langle \chi_1, e_1 \rangle, \dots, \langle \chi_n, e_n \rangle\}$.

In the **special case of all operators of ω being relaxed**, we further define:

- Plan step ω is **applicable** in state s iff $s \models \chi_i$ for all $i \in \{1, \dots, n\}$.
- The **result** of applying ω to s , in symbols $app_\omega(s)$, is defined as the state s' with $on(s') = on(s) \cup \bigcup_{i=1}^n [e_i]_s$.

general semantics for plan steps \rightsquigarrow much later

- Parallel plans
- Plan steps
- Forward distances
- Relaxed planning graphs
- Relaxation heuristics
- Summary

November 19th, 2014

B. Nebel, R. Mattmüller – AI Planning

5 / 62

In all cases, $s = \{a \mapsto 0, b \mapsto 0, c \mapsto 1, d \mapsto 0\}$.

- $\omega = \{\langle c, a \rangle, \langle \top, b \rangle\}$
- $\omega = \{\langle c, a \rangle, \langle c, a \triangleright b \rangle\}$
- $\omega = \{\langle c, a \wedge b \rangle, \langle a, b \triangleright d \rangle\}$
- $\omega = \{\langle c, a \wedge (b \triangleright d) \rangle, \langle c, b \wedge (a \triangleright d) \rangle\}$

Applying a relaxed plan step to a state is related to applying the operators in the step to a state in sequence.

Definition (serialization)

A **serialization** of plan step $\omega = \{o_1^+, \dots, o_n^+\}$ is a sequence $o_{\pi(1)}^+, \dots, o_{\pi(n)}^+$ where π is a permutation of $\{1, \dots, n\}$.

Lemma (conservativeness of plan step semantics)

If ω is a plan step applicable in a state s of a relaxed planning task, then each serialization o_1, \dots, o_n of ω is applicable in s and $app_{o_1, \dots, o_n}(s)$ dominates $app_{\omega}(s)$.

- Does equality hold for all/some serialization(s)?
- What if there are no conditional effects?
- What if we allowed general (unrelaxed) planning tasks?

Definition (parallel plan)

A **parallel plan** for a relaxed planning task $\langle A, I, O^+, \gamma \rangle$ is a sequence of plan steps $\omega_1, \dots, \omega_n$ of operators in O^+ with:

- $s_0 := I$
- For $i = 1, \dots, n$, step ω_i is applicable in s_{i-1} and $s_i := app_{\omega_i}(s_{i-1})$.
- $s_n \models \gamma$

Remark: By ordering the operators within each single step arbitrarily, we obtain a (regular, non-parallel) plan.

Idea: In the forward phase of the heuristic computation,

- 1 apply plan step with **all operators applicable initially**,
- 2 apply plan step with **all operators applicable then**,
- 3 and so on.

Definition (forward state/plan step/set)

Let $\Pi^+ = \langle A, I, O^+, \gamma \rangle$ be a relaxed planning task.

The **n -th forward state**, in symbols s_n^F ($n \in \mathbb{N}_0$), the **n -th forward plan step**, in symbols ω_n^F ($n \in \mathbb{N}_1$), and the **n -th forward set**, in symbols S_n^F ($n \in \mathbb{N}_0$), are defined as:

- $s_0^F := I$
- $\omega_n^F := \{o \in O^+ \mid o \text{ applicable in } s_{n-1}^F\}$ for all $n \in \mathbb{N}_1$
- $s_n^F := app_{\omega_n^F}(s_{n-1}^F)$ for all $n \in \mathbb{N}_1$
- $S_n^F := on(s_n^F)$ for all $n \in \mathbb{N}_0$

The max heuristic h_{\max}



Definition (parallel forward distance)

The **parallel forward distance** of a relaxed planning task $\langle A, I, O^+, \gamma \rangle$ is the lowest number $n \in \mathbb{N}_0$ such that $s_n^F \models \gamma$, or ∞ if no forward state satisfies γ .

Remark: The parallel forward distance can be computed in polynomial time. (How?)

Definition (max heuristic h_{\max})

Let $\Pi = \langle A, I, O, \gamma \rangle$ be a planning task in positive normal form, and let s be a state of Π .

The **max heuristic** estimate for s , $h_{\max}(s)$, is the parallel forward distance of the relaxed planning task $\langle A, s, O^+, \gamma \rangle$.

Remark: h_{\max} is safe, goal-aware, admissible and consistent. (Why?)

Parallel plans
Plan steps
Forward distances
Relaxed planning graphs
Relaxation heuristics
Summary

So far, so good...



- We have seen how systematic computation of forward states leads to an admissible heuristic estimate.
- However, this estimate is **very coarse**.
- To improve it, we need to include **backward propagation** of information.

For this purpose, we use so-called **relaxed planning graphs**.

Parallel plans
Plan steps
Forward distances
Relaxed planning graphs
Relaxation heuristics
Summary

2 Relaxed planning graphs



- Introduction
- Construction
- Truth values

Parallel plans
Relaxed planning graphs
Introduction
Construction
Truth values
Relaxation heuristics
Summary

AND/OR dags



Definition (AND/OR dag)

An **AND/OR dag** $\langle V, A, type \rangle$ is a directed acyclic graph $\langle V, A \rangle$ with a label function $type : V \rightarrow \{\wedge, \vee\}$ partitioning nodes into **AND nodes** ($type(v) = \wedge$) and **OR nodes** ($type(v) = \vee$).

Note: AND nodes drawn as squares, OR nodes as circles.

Definition (truth values in AND/OR dags)

Let $G = \langle V, A, type \rangle$ be an AND/OR dag, and let $u \in V$ be a node with successor set $\{v_1, \dots, v_k\} \subseteq V$.

The (truth) **value** of u , $val(u)$, is inductively defined as:

- If $type(u) = \wedge$, then $val(u) = val(v_1) \wedge \dots \wedge val(v_k)$.
- If $type(u) = \vee$, then $val(u) = val(v_1) \vee \dots \vee val(v_k)$.

Parallel plans
Relaxed planning graphs
Introduction
Construction
Truth values
Relaxation heuristics
Summary

Let Π^+ be a relaxed planning task, and let $k \in \mathbb{N}_0$.

The **relaxed planning graph** of Π^+ for depth k , in symbols $RPG_k(\Pi^+)$, is an AND/OR dag that encodes

- **which propositions** can be made true in k plan steps, and
- **how** they can be made true.

Its construction is a bit involved, so we present it in stages.

As a running example, consider the relaxed planning task $\langle A, I, \{o_1, o_2, o_3, o_4\}, \gamma \rangle$ with

$$A = \{a, b, c, d, e, f, g, h\}$$

$$I = \{a \mapsto 1, b \mapsto 0, c \mapsto 1, d \mapsto 1,$$

$$e \mapsto 0, f \mapsto 0, g \mapsto 0, h \mapsto 0\}$$

$$o_1 = \langle b \vee (c \wedge d), b \wedge ((a \wedge b) \triangleright e) \rangle$$

$$o_2 = \langle \top, f \rangle$$

$$o_3 = \langle f, g \rangle$$

$$o_4 = \langle f, h \rangle$$

$$\gamma = e \wedge (g \wedge h)$$

$$I = \{a \mapsto 1, b \mapsto 0, c \mapsto 1, d \mapsto 1, e \mapsto 0, f \mapsto 0, g \mapsto 0, h \mapsto 0\}$$

$$o_1 = \langle b \vee (c \wedge d), b \wedge ((a \wedge b) \triangleright e) \rangle$$

$$o_2 = \langle \top, f \rangle, \quad o_3 = \langle f, g \rangle, \quad o_4 = \langle f, h \rangle$$

$$S_0^F = \{a, c, d\}$$

$$\omega_1^F = \{o_1, o_2\}$$

$$S_1^F = \{a, b, c, d, f\}$$

$$\omega_2^F = \{o_1, o_2, o_3, o_4\}$$

$$S_2^F = \{a, b, c, d, e, f, g, h\}$$

$$\omega_3^F = \omega_2^F$$

$$S_3^F = S_2^F \text{ etc.}$$

A relaxed planning graph consists of four kinds of components:

- **Proposition nodes** represent the truth value of propositions after applying a certain number of plan steps.
- **Idle arcs** represent the fact that state variables, once true, remain true.
- **Operator subgraphs** represent the possibility and effect of applying a given operator in a given plan step.
- The **goal subgraph** represents the truth value of the goal condition after k plan steps.

Relaxed planning graph: proposition layers



- Parallel plans
- Relaxed planning graphs
- Introduction
- Construction
- Truth values
- Relaxation heuristics
- Summary

Let $\Pi^+ = \langle A, I, O^+, \gamma \rangle$ be a relaxed planning task, let $k \in \mathbb{N}_0$.

For each $i \in \{0, \dots, k\}$, $RPG_k(\Pi^+)$ contains one **proposition layer** which consists of:

- a **proposition node** a^i for each state variable $a \in A$.

Node a^i is an AND node if $i = 0$ and $I \models a$.
Otherwise, it is an OR node.

Relaxed planning graph: proposition layers



- Parallel plans
- Relaxed planning graphs
- Introduction
- Construction
- Truth values
- Relaxation heuristics
- Summary

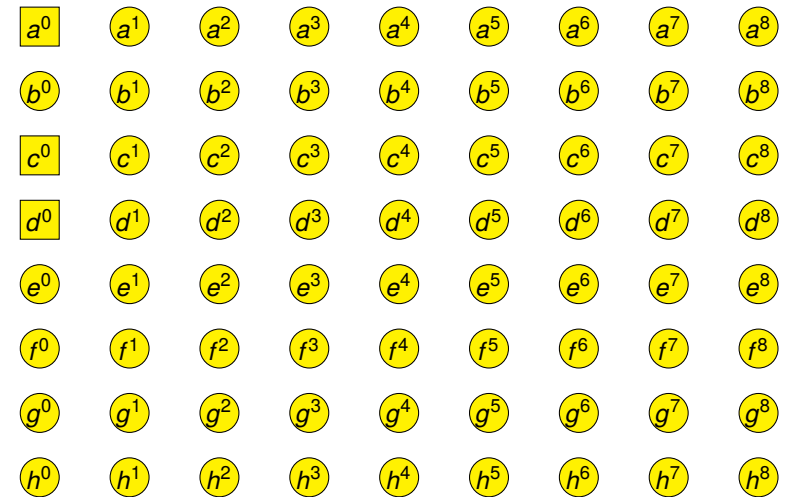

Relaxed planning graph: idle arcs



- Parallel plans
- Relaxed planning graphs
- Introduction
- Construction
- Truth values
- Relaxation heuristics
- Summary

For each proposition node a^i with $i \in \{1, \dots, k\}$, $RPG_k(\Pi^+)$ contains an arc from a^i to a^{i-1} (**idle arcs**).

Intuition: If a state variable is true in step i , one of the possible reasons is that it **was already previously true**.

Relaxed planning graph: idle arcs



- Parallel plans
- Relaxed planning graphs
- Introduction
- Construction
- Truth values
- Relaxation heuristics
- Summary

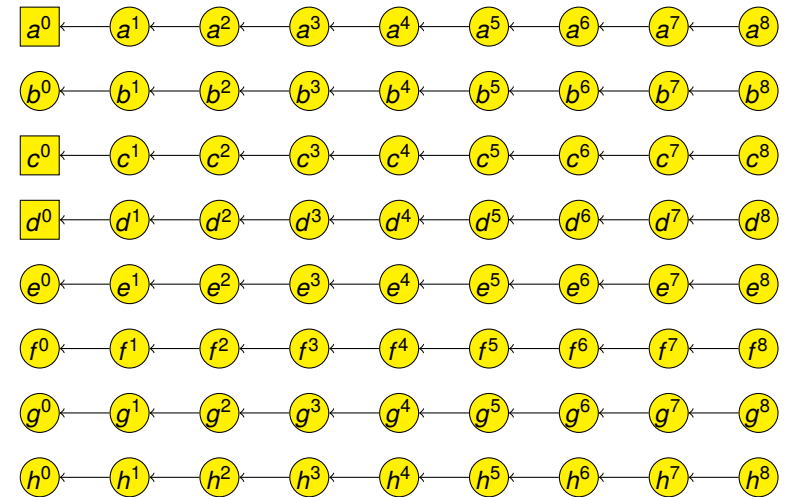

Relaxed planning graph: operator subgraphs

For each $i \in \{1, \dots, k\}$ and each operator $o^+ = \langle \chi, e^+ \rangle \in O^+$, $RPG_k(\Pi^+)$ contains a subgraph called an **operator subgraph** with the following parts:

- one **formula node** n_φ^i for each formula φ which is a subformula of χ or of some effect condition in e^+ :
 - If $\varphi = a$ for some atom a , n_φ^i is the proposition node a^{i-1} .
 - If $\varphi = \top$, n_φ^i is a new AND node without outgoing arcs.
 - If $\varphi = \perp$, n_φ^i is a new OR node without outgoing arcs.
 - If $\varphi = (\varphi' \wedge \varphi'')$, n_φ^i is a new AND node with outgoing arcs to $n_{\varphi'}^i$ and $n_{\varphi''}^i$.
 - If $\varphi = (\varphi' \vee \varphi'')$, n_φ^i is a new OR node with outgoing arcs to $n_{\varphi'}^i$ and $n_{\varphi''}^i$.

Relaxed planning graph: operator subgraphs

For each $i \in \{1, \dots, k\}$ and each operator $o^+ = \langle \chi, e^+ \rangle \in O^+$, $RPG_k(\Pi^+)$ contains a subgraph called an **operator subgraph** with the following parts:

- for each conditional effect $(\chi' \triangleright a)$ in e^+ , an **effect node** $o_{\chi'}^i$ (an AND node) with outgoing arcs to the precondition formula node $n_{\chi'}^i$ and effect condition formula node $n_{\chi'}^i$, and incoming arc from proposition node a^i
 - unconditional effects a (effects which are not part of a conditional effect) are treated the same, except that there is no arc to an effect condition formula node
 - effects with identical condition (including groups of unconditional effects) share the same effect node
 - the effect node for unconditional effects is denoted by o^i

Relaxed planning graph: operator subgraphs

Operator subgraph for $o_1 = \langle b \vee (c \wedge d), b \wedge ((a \wedge b) \triangleright e) \rangle$ for layer $i = 1$.

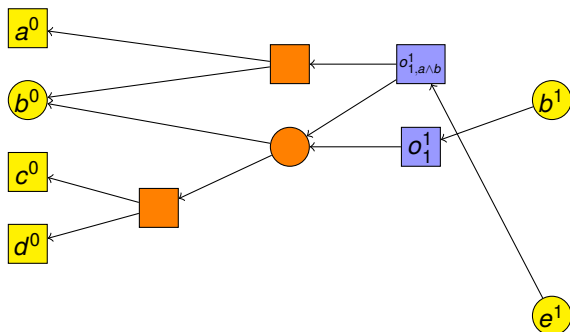

Relaxed planning graph: goal subgraph

$RPG_k(\Pi^+)$ contains a subgraph called a **goal subgraph** with the following parts:

- one **formula node** n_φ^k for each formula φ which is a subformula of γ :
 - If $\varphi = a$ for some atom a , n_φ^k is the proposition node a^i .
 - If $\varphi = \top$, n_φ^k is a new AND node without outgoing arcs.
 - If $\varphi = \perp$, n_φ^k is a new OR node without outgoing arcs.
 - If $\varphi = (\varphi' \wedge \varphi'')$, n_φ^k is a new AND node with outgoing arcs to $n_{\varphi'}^k$ and $n_{\varphi''}^k$.
 - If $\varphi = (\varphi' \vee \varphi'')$, n_φ^k is a new OR node with outgoing arcs to $n_{\varphi'}^k$ and $n_{\varphi''}^k$.

The node n_γ^k is called the **goal node**.

Relaxed planning graph: goal subgraphs

Goal subgraph for $\gamma = e \wedge (g \wedge h)$ and depth $k = 2$:

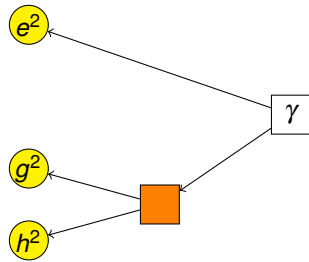

- Parallel plans
- Relaxed planning graphs
- Introduction
- Construction
- Truth values
- Relaxation heuristics
- Summary

Relaxed planning graph: complete (depth 2)

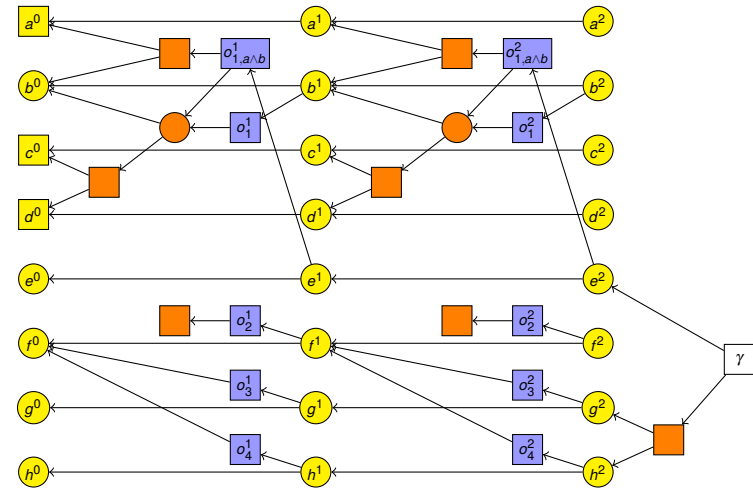

- Parallel plans
- Relaxed planning graphs
- Introduction
- Construction
- Truth values
- Relaxation heuristics
- Summary

Connection to forward sets and plan steps

Theorem (relaxed planning graph truth values)

Let $\Pi^+ = \langle A, I, O^+, \gamma \rangle$ be a relaxed planning task. Then the truth values of the nodes of its depth- k relaxed planning graph $RPG_k(\Pi^+)$ relate to the forward sets and forward plan steps of Π^+ as follows:

- **Proposition nodes:**
For all $a \in A$ and $i \in \{0, \dots, k\}$, $val(a^i) = 1$ iff $a \in S_i^F$.
- **(Unconditional) effect nodes:**
For all $o \in O^+$ and $i \in \{1, \dots, k\}$, $val(o^i) = 1$ iff $o \in \omega_i^F$.
- **Goal nodes:**
 $val(n_\gamma^k) = 1$ iff the parallel forward distance of Π^+ is at most k .

(We omit the straight-forward proof.)

- Parallel plans
- Relaxed planning graphs
- Introduction
- Construction
- Truth values
- Relaxation heuristics
- Summary

Computing the node truth values

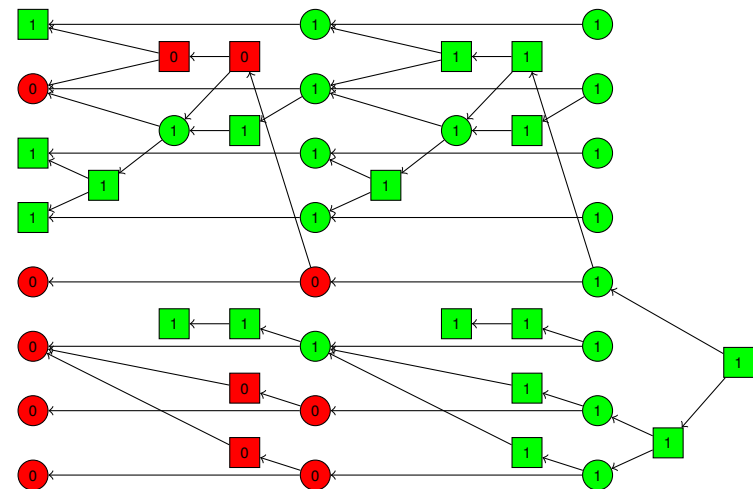

- Parallel plans
- Relaxed planning graphs
- Introduction
- Construction
- Truth values
- Relaxation heuristics
- Summary

Remark: Relaxed planning graphs have historically been defined for STRIPS tasks only. In this case, we can simplify:

- **Only one effect node per operator:** STRIPS does not have conditional effects.
 - Because each operator has only one effect node, effect nodes are called **operator nodes** in relaxed planning graphs for STRIPS.
- **No goal nodes:** The test whether all goals are reached is done by the algorithm that evaluates the AND/OR dag.
- **No formula nodes:** Operator nodes are directly connected to their preconditions.

↔ Relaxed planning graphs for STRIPS are **layered** digraphs and only have **proposition and operator nodes**.

- Parallel plans
- Relaxed planning graphs
- Introduction
- Construction
- Truth values
- Relaxation heuristics
- Summary

- Generic template for relaxation heuristics
- The max heuristic h_{max}
- The additive heuristic h_{add}
- The set-additive heuristic h_{sa}
- Incremental computation
- The FF heuristic h_{FF}
- Comparison & relaxation heuristics in practice

- Parallel plans
- Relaxed planning graphs
- Relaxation heuristics
- Generic template
- h_{max}
- h_{add}
- h_{sa}
- Incremental computation
- h_{FF}
- Comparison & practice
- Summary

So far, relaxed planning graphs offer us a way to compute parallel forward distances:

Parallel forward distances from relaxed planning graphs

def *parallel-forward-distance*(Π^+):

Let A be the set of state variables of Π^+ .

for $k \in \{0, 1, 2, \dots\}$:

$rpg := RPG_k(\Pi^+)$

Evaluate truth values for rpg .

if goal node of rpg has value 1:

return k

else if $k = |A|$:

return ∞

- Parallel plans
- Relaxed planning graphs
- Relaxation heuristics
- Generic template
- h_{max}
- h_{add}
- h_{sa}
- Incremental computation
- h_{FF}
- Comparison & practice
- Summary

- The relaxed planning graph for depth $k \geq 1$ can be built **incrementally** from the one for depth $k - 1$:
 - Add new layer k .
 - Move goal subgraph from layer $k - 1$ to layer k .
- Similarly, all truth values up to layer $k - 1$ can be reused.
- Thus, overall computation with maximal depth m requires time $O(\|RPG_m(\Pi^+)\|) = O((m + 1) \cdot \|\Pi^+\|)$.
- This is not a very efficient way of computing parallel forward distances (and wouldn't be used in practice).
- However, it allows computing **additional information** for the relaxed planning graph nodes along the way, which can be used for heuristic estimates.

- Parallel plans
- Relaxed planning graphs
- Relaxation heuristics
- Generic template
- h_{max}
- h_{add}
- h_{sa}
- Incremental computation
- h_{FF}
- Comparison & practice
- Summary

Generic relaxed planning graph heuristics



Computing heuristics from relaxed planning graphs

```

def generic-rpg-heuristic( $\langle A, I, O, \gamma \rangle, s$ ):
     $\Pi^+ := \langle A, s, O^+, \gamma \rangle$ 
    for  $k \in \{0, 1, 2, \dots\}$ :
         $rpg := RPG_k(\Pi^+)$ 
        Evaluate truth values for  $rpg$ .
        if goal node of  $rpg$  has value 1:
            Annotate true nodes of  $rpg$ .
            if termination criterion is true:
                return heuristic value from annotations
        else if  $k = |A|$ :
            return  $\infty$ 
    
```

Parallel plans
Relaxed planning graphs
Relaxation heuristics
Generic template
 h_{max}
 h_{add}
 h_{sa}
Incremental computation
 h_{cs}
Comparison & practice
Summary

↪ generic template for heuristic functions
↪ to get concrete heuristic: fill in highlighted parts

Concrete examples for the generic heuristic



Many planning heuristics fit the generic template:

- additive heuristic h_{add} (Bonet, Loerincs & Geffner, 1997)
- max heuristic h_{max} (Bonet & Geffner, 1999)
- FF heuristic h_{FF} (Hoffmann & Nebel, 2001)
- cost-sharing heuristic h_{CS} (Mirkis & Domshlak, 2007)
 - not covered in this course
- set-additive heuristic h_{sa} (Keyder & Geffner, 2008)

Remarks:

- For all these heuristics, equivalent definitions that don't refer to relaxed planning graphs are possible.
- Historically, such equivalent definitions have mostly been used for h_{max} , h_{add} and h_{sa} .
- For those heuristics, the most efficient implementations do not use relaxed planning graphs explicitly.

Parallel plans
Relaxed planning graphs
Relaxation heuristics
Generic template
 h_{max}
 h_{add}
 h_{sa}
Incremental computation
 h_{cs}
Comparison & practice
Summary

Forward cost heuristics



- The simplest relaxed planning graph heuristics are forward cost heuristics.
- Examples: h_{max} , h_{add}
- Here, node annotations are cost values (natural numbers).
- The cost of a node estimates how expensive (in terms of required operators) it is to make this node true.

Parallel plans
Relaxed planning graphs
Relaxation heuristics
Generic template
 h_{max}
 h_{add}
 h_{sa}
Incremental computation
 h_{cs}
Comparison & practice
Summary

Forward cost heuristics: fitting the template



Forward cost heuristics

Computing annotations:

- Propagate cost values bottom-up using a combination rules for OR nodes and for AND nodes.
- At effect nodes, add 1 after applying combination rule.

Termination criterion:

- stability: terminate if cost for proposition node a^k equals cost for a^{k-1} for all true propositions a in layer k

Heuristic value:

- The heuristic value is the cost of the goal node.
- Different forward cost heuristics only differ in their choice of combination rules.

Parallel plans
Relaxed planning graphs
Relaxation heuristics
Generic template
 h_{max}
 h_{add}
 h_{sa}
Incremental computation
 h_{cs}
Comparison & practice
Summary

The max heuristic h_{\max} (again)



Forward cost heuristics: max heuristic h_{\max}

Combination rule for AND nodes:

- $cost(u) = \max(\{cost(v_1), \dots, cost(v_k)\})$
(with $\max(\emptyset) := 0$)

Combination rule for OR nodes:

- $cost(u) = \min(\{cost(v_1), \dots, cost(v_k)\})$

In both cases, $\{v_1, \dots, v_k\}$ is the set of true successors of u .

Intuition:

- AND rule:** If we have to achieve several conditions, estimate this by the **most expensive** cost.
- OR rule:** If we have a choice how to achieve a condition, pick the **cheapest** possibility.

- Parallel plans
- Relaxed planning graphs
- Relaxation heuristics
 - Generic template
 - h_{\max}
 - h_{add}
 - h_{sa}
 - Incremental computation
 - h_{ps}
 - Comparison & practice
- Summary

Running example: h_{\max}

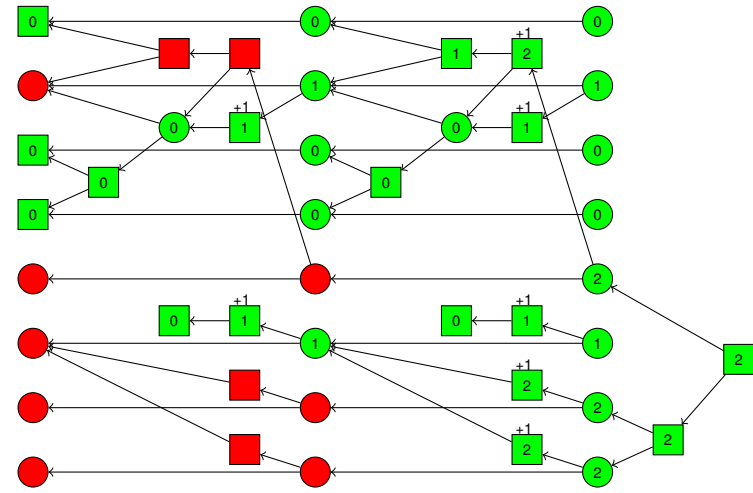

- Parallel plans
- Relaxed planning graphs
- Relaxation heuristics
 - Generic template
 - h_{\max}
 - h_{add}
 - h_{sa}
 - Incremental computation
 - h_{ps}
 - Comparison & practice
- Summary

Remarks on h_{\max}



- The definition of h_{\max} as a forward cost heuristic is equivalent to our earlier definition in this chapter.
- Unlike the earlier definition, it generalizes to an extension where every operator has an associated non-negative **cost** (rather than all operators having cost 1).
- In the case without costs (and only then), it is easy to prove that the goal node has the same cost in all graphs $RPG_k(\Pi^+)$ where it is true. (Namely, the cost is equal to the lowest value of k for which the goal node is true.)
- We can thus terminate the computation as soon as the goal becomes true, without waiting for stability.
- The same is **not true** for other forward-propagating heuristics (h_{add} , h_{cs} , h_{sa}).

- Parallel plans
- Relaxed planning graphs
- Relaxation heuristics
 - Generic template
 - h_{\max}
 - h_{add}
 - h_{sa}
 - Incremental computation
 - h_{ps}
 - Comparison & practice
- Summary

The additive heuristic



Forward cost heuristics: additive heuristic h_{add}

Combination rule for AND nodes:

- $cost(u) = cost(v_1) + \dots + cost(v_k)$
(with $\sum(\emptyset) := 0$)

Combination rule for OR nodes:

- $cost(u) = \min(\{cost(v_1), \dots, cost(v_k)\})$

In both cases, $\{v_1, \dots, v_k\}$ is the set of true successors of u .

Intuition:

- AND rule:** If we have to achieve several conditions, estimate this by the cost of achieving **each in isolation**.
- OR rule:** If we have a choice how to achieve a condition, pick the **cheapest** possibility.

- Parallel plans
- Relaxed planning graphs
- Relaxation heuristics
 - Generic template
 - h_{\max}
 - h_{add}
 - h_{sa}
 - Incremental computation
 - h_{ps}
 - Comparison & practice
- Summary

Running example: h_{add}

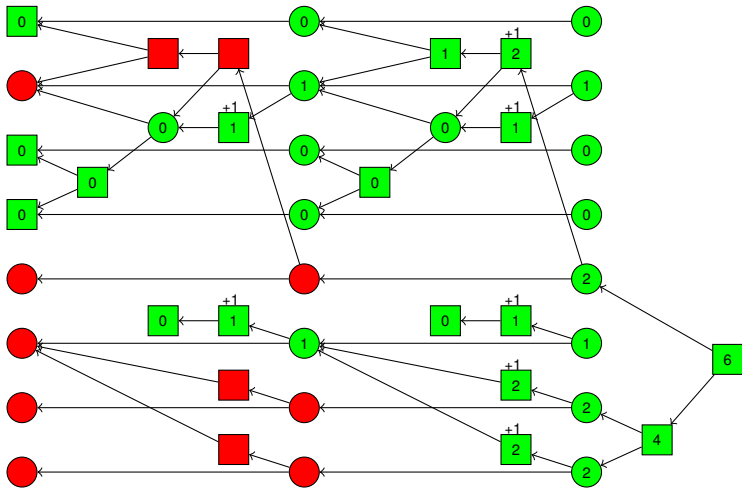

Parallel plans
Relaxed planning graphs
Relaxation heuristics
Generic template
 h_{max}
 h_{add}
 h_{sa}
Incremental computation
 h_{fs}
Comparison & practice
Summary

Remarks on h_{add}

- It is important to test for stability in computing h_{add} ! (The reason for this is that, unlike h_{max} , cost values of true propositions can **decrease** from layer to layer.)
- Stability is achieved after layer $|A|$ in the worst case.
- h_{add} is **safe** and **goal-aware**.
- Unlike h_{max} , h_{add} is a **very informative** heuristic in many planning domains.
- The price for this is that it is **not admissible** (and hence also **not consistent**), so not suitable for optimal planning.
- In fact, it **almost always** overestimates the h^+ value because it does not take **positive interactions** into account.

Parallel plans
Relaxed planning graphs
Relaxation heuristics
Generic template
 h_{max}
 h_{add}
 h_{sa}
Incremental computation
 h_{fs}
Comparison & practice
Summary

The set-additive heuristic

- We now discuss a refinement of the additive heuristic called the **set-additive heuristic h_{sa}** .
- The set-additive heuristic addresses the problem that h_{add} does not take positive interactions into account.
- Like h_{max} and h_{add} , h_{sa} is calculated through **forward propagation** of node annotations.
- However, the node annotations are not cost values, but **sets of operators** (kind of).
- The idea is that by taking **set unions** instead of **adding costs**, operators needed only once are **counted only once**.

Disclaimer: There are some quite subtle differences between the h_{sa} heuristic as we describe it here and the “real” heuristic of Keyder & Geffner. We do not want to discuss this in detail, but please note that such differences exist.

Parallel plans
Relaxed planning graphs
Relaxation heuristics
Generic template
 h_{max}
 h_{add}
 h_{sa}
Incremental computation
 h_{fs}
Comparison & practice
Summary

Operators needed several times

- The original h_{sa} heuristic as described in the literature is defined for STRIPS tasks and propagates **sets of operators**.
- This is fine because in relaxed STRIPS tasks, each operator **need only be applied once**.
- The same is **not true in general**: in our running example, operator o_1 must be applied twice in the relaxed plan.
- In general, it only makes sense to apply an operator again in a relaxed planning task if a **previously unsatisfied effect condition** has been made true.
- For this reason, we keep track of **operator/effect condition pairs** rather than just plain operators.

Parallel plans
Relaxed planning graphs
Relaxation heuristics
Generic template
 h_{max}
 h_{add}
 h_{sa}
Incremental computation
 h_{fs}
Comparison & practice
Summary

Set-additive heuristic: fitting the template

The set-additive heuristic h_{sa}

Computing annotations:

- Annotations are **sets of operator/effect condition pairs**, computed bottom-up.

Combination rule for AND nodes:

- $ann(u) = ann(v_1) \cup \dots \cup ann(v_k)$ (with $\cup(\emptyset) := \emptyset$)

Combination rule for OR nodes:

- $ann(u) = ann(v_i)$ for some v_i minimizing $|ann(v_i)|$
In case of several minimizers, use any tie-breaking rule.

In both cases, $\{v_1, \dots, v_k\}$ is the set of true successors of u . At **effect nodes**, add the corresponding operator/effect condition pair to the set after applying combination rule.

...

Set-additive heuristic: fitting the template (ctd.)

The set-additive heuristic h_{sa} (ctd.)

Computing annotations:

- ... (Effect nodes for unconditional effects are represented just by the operator, without a condition.)

Termination criterion:

- stability**: terminate if set for proposition node a^k has same cardinality as for a^{k-1} for all true propositions a in layer k

Heuristic value:

- The heuristic value is the **set cardinality** of the goal node annotation.

Running example: h_{sa}

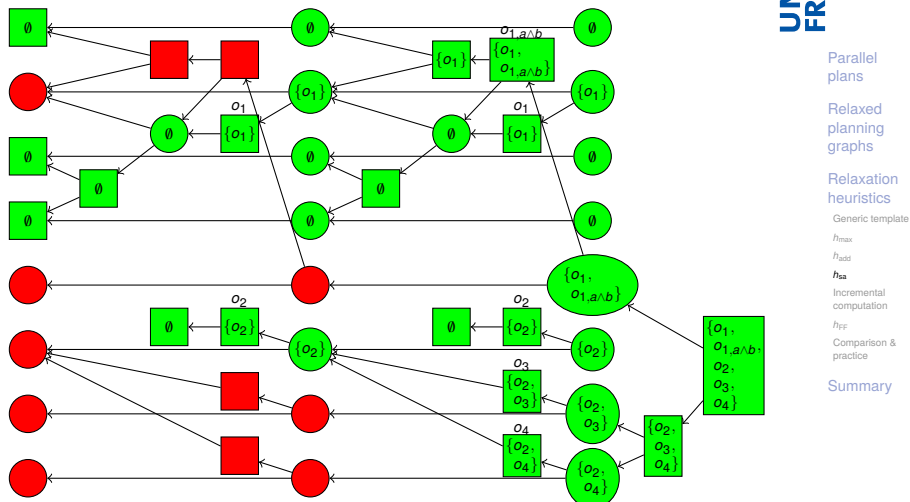

Remarks on h_{sa}

- The same remarks for stability as for h_{add} apply.
- Like h_{add} , h_{sa} is **safe** and **goal-aware**, but neither **admissible** nor **consistent**.
- h_{sa} is generally **better informed** than h_{add} , but significantly more expensive to compute.
- The h_{sa} value depends on the tie-breaking rule used, so h_{sa} is **not well-defined** without specifying the tie-breaking rule.
- The operators contained in the goal node annotation, suitably ordered, define a **relaxed plan** for the task.
 - Operators mentioned several times in the annotation must be added as many times in the relaxed plan.

Incremental computation of forward heuristics



- Parallel plans
- Relaxed planning graphs
- Relaxation heuristics
- Generic template
- h_{max}
- h_{add}
- h_{sa}
- Incremental computation
- h_{fs}
- Comparison & practice
- Summary

One nice property of forward-propagating heuristics is that they allow **incremental computation**:

- when evaluating several states in sequence which only differ in a few state variables, can
 - start computation from previous results and
 - keep track only of what needs to be recomputed
- typical use case: **depth-first** style searches (e. g., IDA*)
- rarely exploited in practice

Incremental computation example: h_{add}



- Parallel plans
- Relaxed planning graphs
- Relaxation heuristics
- Generic template
- h_{max}
- h_{add}
- h_{sa}
- Incremental computation
- h_{fs}
- Comparison & practice
- Summary

Result for $\{a \mapsto 1, b \mapsto 0, c \mapsto 1, d \mapsto 1, e \mapsto 0, f \mapsto 0, g \mapsto 0, h \mapsto 0\}$

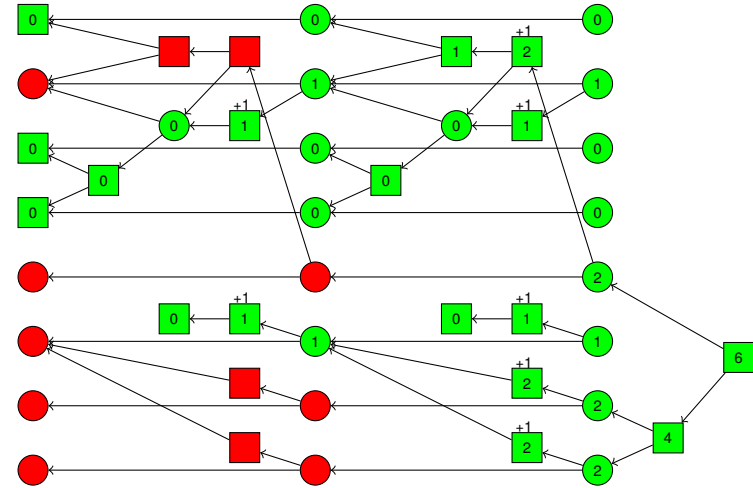

Incremental computation example: h_{add}



- Parallel plans
- Relaxed planning graphs
- Relaxation heuristics
- Generic template
- h_{max}
- h_{add}
- h_{sa}
- Incremental computation
- h_{fs}
- Comparison & practice
- Summary

Change value of **e** to 1.

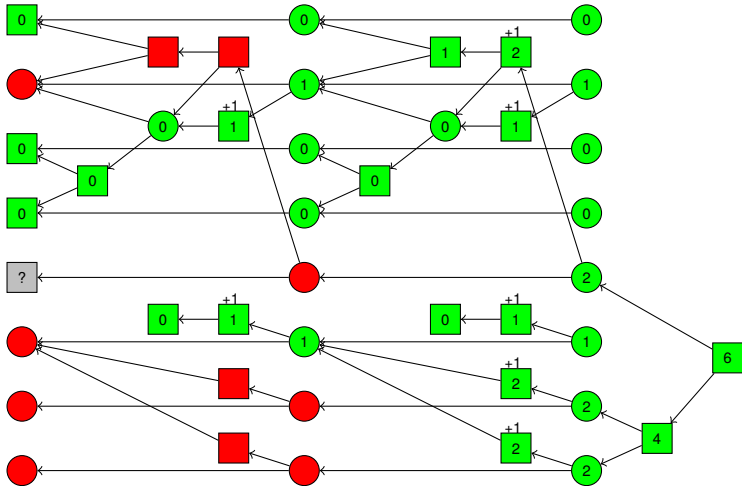

Incremental computation example: h_{add}



- Parallel plans
- Relaxed planning graphs
- Relaxation heuristics
- Generic template
- h_{max}
- h_{add}
- h_{sa}
- Incremental computation
- h_{fs}
- Comparison & practice
- Summary

Recompute outdated values.

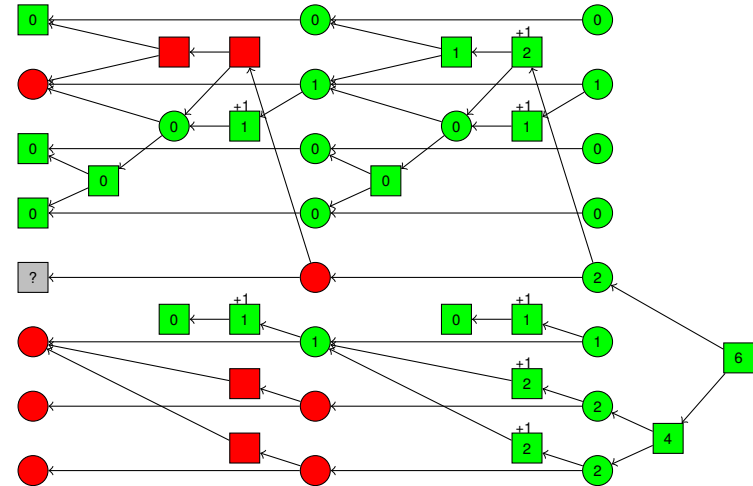

Incremental computation example: h_{add}



Recompute outdated values.

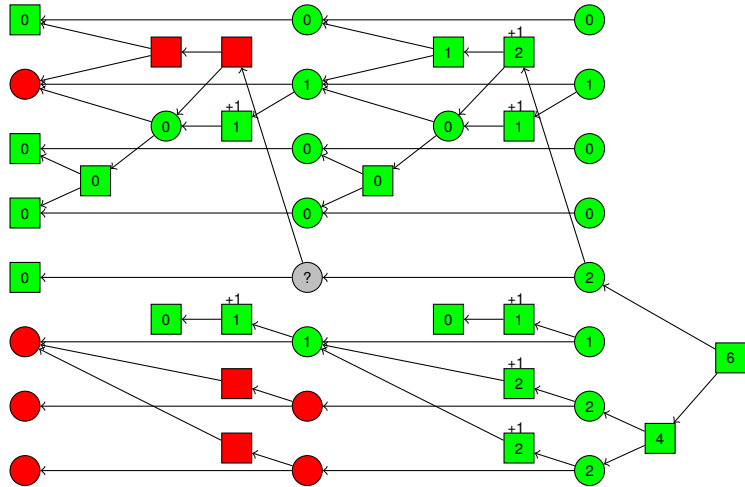

- Parallel plans
- Relaxed planning graphs
- Relaxation heuristics
 - Generic template
 - h_{max}
 - h_{add}
 - h_{ca}
- Incremental computation
 - h_{is}
- Comparison & practice
- Summary

Incremental computation example: h_{add}



Recompute outdated values.

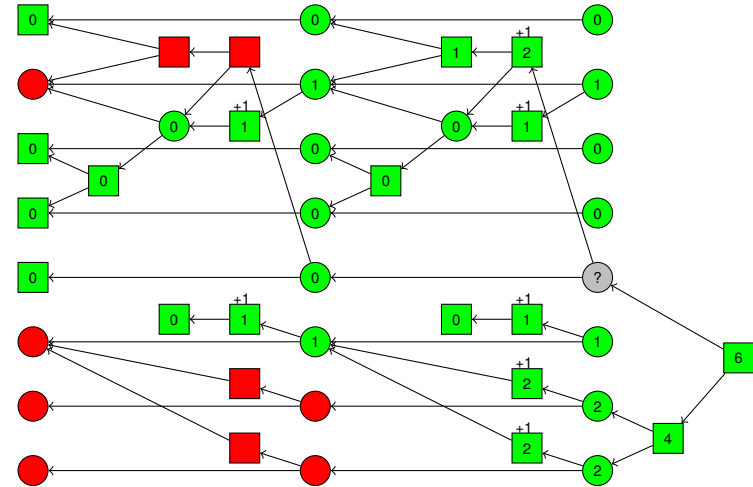

- Parallel plans
- Relaxed planning graphs
- Relaxation heuristics
 - Generic template
 - h_{max}
 - h_{add}
 - h_{ca}
- Incremental computation
 - h_{is}
- Comparison & practice
- Summary

Incremental computation example: h_{add}



Recompute outdated values.

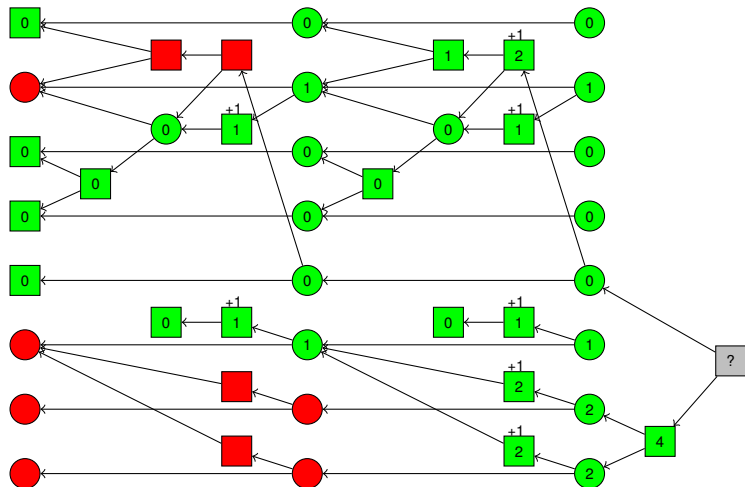

- Parallel plans
- Relaxed planning graphs
- Relaxation heuristics
 - Generic template
 - h_{max}
 - h_{add}
 - h_{ca}
- Incremental computation
 - h_{is}
- Comparison & practice
- Summary

Incremental computation example: h_{add}



Recompute outdated values.

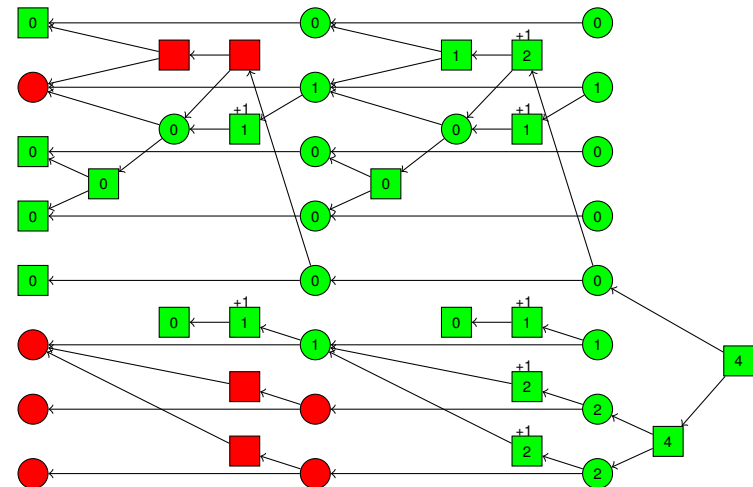

- Parallel plans
- Relaxed planning graphs
- Relaxation heuristics
 - Generic template
 - h_{max}
 - h_{add}
 - h_{ca}
- Incremental computation
 - h_{is}
- Comparison & practice
- Summary

Heuristic estimate h_{FF}



- h_{sa} is more expensive to compute than the other forward propagating heuristics because we must propagate **sets**.
- It is possible to get the same advantage over h_{add} combined with efficient propagation.
- Key idea of h_{FF} : perform a **backward propagation** that selects a sufficient subset of nodes to make the goal true (called a **solution graph** in AND/OR dag literature).
- The resulting heuristic is almost as informative as h_{sa} , yet computable as quickly as h_{add} .

Note: Our presentation inverts the historical order. The set-additive heuristic was defined **after** the FF heuristic (sacrificing speed for even higher informativeness).

Parallel plans
Relaxed planning graphs
Relaxation heuristics
Generic template
 h_{max}
 h_{add}
 h_{sa}
Incremental computation
 h_{FF}
Comparison & practice
Summary

FF heuristic: fitting the template



The FF heuristic h_{FF}

Computing annotations:

- Annotations are **Boolean values**, computed top-down. A node is **marked** when its annotation is set to 1 and **unmarked** if it is set to 0. Initially, the goal node is marked, and all other nodes are unmarked.
- We say that a true AND node is **justified** if all its true successors are marked, and that a true OR node is **justified** if at least one of its true successors is marked.
- ...

Parallel plans
Relaxed planning graphs
Relaxation heuristics
Generic template
 h_{max}
 h_{add}
 h_{sa}
Incremental computation
 h_{FF}
Comparison & practice
Summary

FF heuristic: fitting the template (ctd.)



The FF heuristic h_{FF} (ctd.)

Computing annotations:

- ...
Apply these rules until **all marked nodes are justified**:
 - 1 Mark all true successors of a marked unjustified AND node.
 - 2 Mark the true successor of a marked unjustified OR node with only one true successor.
 - 3 Mark a true successor of a marked unjustified OR node connected via an idle arc.
 - 4 Mark any true successor of a marked unjustified OR node.

The rules are given in priority order: earlier rules are preferred if applicable.

Parallel plans
Relaxed planning graphs
Relaxation heuristics
Generic template
 h_{max}
 h_{add}
 h_{sa}
Incremental computation
 h_{FF}
Comparison & practice
Summary

FF heuristic: fitting the template (ctd.)



The FF heuristic h_{FF} (ctd.)

Termination criterion:

- **Always terminate** at first layer where goal node is true.

Heuristic value:

- The heuristic value is the **number of operator/effect condition pairs** for which **at least one** effect node is marked.

Parallel plans
Relaxed planning graphs
Relaxation heuristics
Generic template
 h_{max}
 h_{add}
 h_{sa}
Incremental computation
 h_{FF}
Comparison & practice
Summary

Running example: h_{FF}

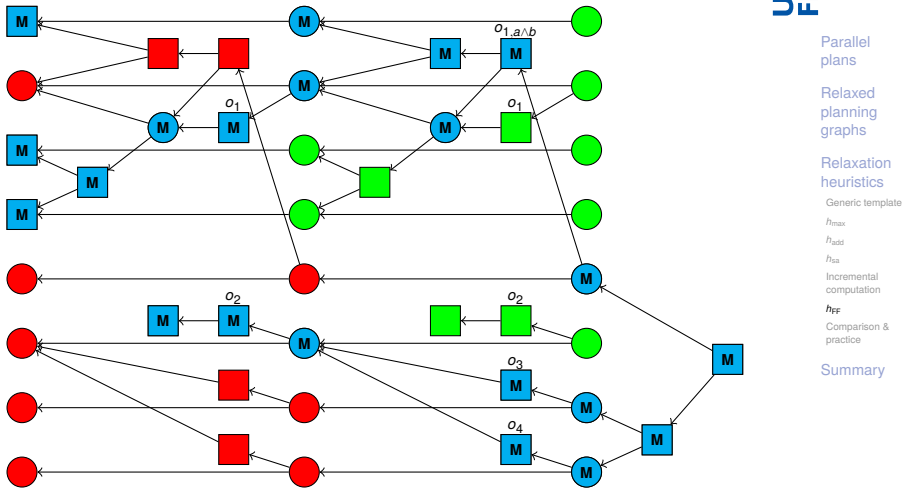

- Parallel plans
- Relaxed planning graphs
- Relaxation heuristics
- Generic template
- h_{max}
- h_{sa}
- h_{FF}
- Incremental computation
- h_{FF}
- Comparison & practice
- Summary

Remarks on h_{FF}

- Like h_{add} and h_{sa} , h_{FF} is **safe** and **goal-aware**, but neither **admissible** nor **consistent**.
- Its informativeness can be expected to be slightly worse than for h_{sa} , but is usually not far off.
- Unlike h_{sa} , h_{FF} can be computed in **linear time**.
- Similar to h_{sa} , the operators corresponding to the marked operator/effect condition pairs define a **relaxed plan**.
- Similar to h_{sa} , the h_{FF} value depends on tie-breaking when the marking rules allow several possible choices, so h_{FF} is **not well-defined** without specifying the tie-breaking rule.
 - The implementation in FF uses additional rules of thumb to try to reduce the size of the generated relaxed plan.

- Parallel plans
- Relaxed planning graphs
- Relaxation heuristics
- Generic template
- h_{max}
- h_{sa}
- h_{FF}
- Incremental computation
- h_{FF}
- Comparison & practice
- Summary

Comparison of relaxation heuristics

Theorem (relationship between relaxation heuristics)

Let s be a state of planning task $\langle A, I, O, \gamma \rangle$. Then:

- $h_{max}(s) \leq h^+(s) \leq h^*(s)$
- $h_{max}(s) \leq h^+(s) \leq h_{sa}(s) \leq h_{add}(s)$
- $h_{max}(s) \leq h^+(s) \leq h_{FF}(s) \leq h_{add}(s)$
- h^* , h_{FF} and h_{sa} are pairwise incomparable
- h^* and h_{add} are incomparable

Moreover, h^+ , h_{max} , h_{add} , h_{sa} and h_{FF} assign ∞ to the same set of states.

Note: For **inadmissible** heuristics, dominance is in general neither desirable nor undesirable. For relaxation heuristics, the objective is usually to get as close to h^+ as possible.

- Parallel plans
- Relaxed planning graphs
- Relaxation heuristics
- Generic template
- h_{max}
- h_{sa}
- h_{FF}
- Incremental computation
- h_{FF}
- Comparison & practice
- Summary

Relaxation heuristics in practice: HSP

Example (HSP)

HSP (Bonet & Geffner) was one of the four top performers at the 1st International Planning Competition (IPC-1998).

Key ideas:

- **hill climbing** search using h_{add}
- on **plateaus**, keep going for a number of iterations, then restart
- use a closed list during exploration of plateaus

Literature: Bonet, Loerincs & Geffner (1997), Bonet & Geffner (2001)

- Parallel plans
- Relaxed planning graphs
- Relaxation heuristics
- Generic template
- h_{max}
- h_{sa}
- h_{FF}
- Incremental computation
- h_{FF}
- Comparison & practice
- Summary

Relaxation heuristics in practice: FF



Example (FF)

FF (Hoffmann & Nebel) won the 2nd International Planning Competition (IPC-2000).

Key ideas:

- **enforced hill-climbing** search using h_{FF}
- **helpful action pruning**: in each search node, only consider successors from operators that add one of the atoms marked in proposition layer 1
- **goal ordering**: in certain cases, FF recognizes and exploits that certain subgoals should be solved one after the other

If main search fails, FF performs greedy best-first search using h_{FF} without helpful action pruning or goal ordering.

Parallel plans
Relaxed planning graphs
Relaxation heuristics
Generic template
 h_{max}
 h_{add}
 h_{na}
Incremental computation
 h_{FF}
Comparison & practice
Summary

Relaxation heuristics in practice: Fast Downward



Example (Fast Downward)

Fast Downward (Helmert & Richter) won the satisficing track of the 4th International Planning Competition (IPC-2004).

Key ideas:

- **greedy best-first search** using h_{FF} and **causal graph heuristic** (not relaxation-based)
- search enhancements:
 - multi-heuristic best-first search
 - deferred evaluation of heuristic estimates
 - preferred operators (similar to FF's helpful actions)

Literature: Helmert (2006)

Parallel plans
Relaxed planning graphs
Relaxation heuristics
Generic template
 h_{max}
 h_{add}
 h_{na}
Incremental computation
 h_{FF}
Comparison & practice
Summary

Relaxation heuristics in practice: SGPlan



Example (SGPlan)

SGPlan (Wah, Hsu, Chen & Huang) won the satisficing track of the 5th International Planning Competition (IPC-2006).

Key ideas:

- **FF**
- **problem decomposition** techniques
- **domain-specific techniques**

Literature: Chen, Wah & Hsu (2006)

Parallel plans
Relaxed planning graphs
Relaxation heuristics
Generic template
 h_{max}
 h_{add}
 h_{na}
Incremental computation
 h_{FF}
Comparison & practice
Summary

Relaxation heuristics in practice: LAMA



Example (LAMA)

LAMA (Richter & Westphal) won the satisficing track of the 6th International Planning Competition (IPC-2008).

Key ideas:

- **Fast Downward**
- **landmark pseudo-heuristic** instead of causal graph heuristic ("somewhat" relaxation-based)
- anytime variant of **Weighted A*** instead of greedy best-first search

Literature: Richter, Helmert & Westphal (2008), Richter & Westphal (2010)

Parallel plans
Relaxed planning graphs
Relaxation heuristics
Generic template
 h_{max}
 h_{add}
 h_{na}
Incremental computation
 h_{FF}
Comparison & practice
Summary

- **Relaxed planning graphs** are **AND/OR dags**. They encode which propositions can be made true in Π^+ and how.
 - Closely related to **forward sets** and **forward plan steps**, based on the notion of **parallel relaxed plans**.
 - They can be **constructed and evaluated efficiently**, in time $O((m+1) \|\Pi^+\|)$ for planning task Π and depth m .
- By annotating RPG nodes with appropriate information, we can compute many useful heuristics.
- Examples: **max** heuristic h_{\max} , **additive** heuristic h_{add} , **set-additive** heuristic h_{sa} and **FF** heuristic h_{FF}
 - Of these, only h_{\max} admissible (but not very accurate).
 - The others are much more informative. The set-additive heuristic is the most sophisticated one.
 - The FF heuristic is often similarly informative. It offers a good trade-off between accuracy and computation time.

Parallel plans

Relaxed planning graphs

Relaxation heuristics

Summary