

Principles of AI Planning

8. Planning as search: relaxation heuristics

Bernhard Nebel and Robert Mattmüller

Albert-Ludwigs-Universität Freiburg

November 22nd, 2011

Principles of AI Planning

November 22nd, 2011 — 8. Planning as search: relaxation heuristics

8.1 Parallel plans

8.2 Relaxed planning graphs

8.3 Relaxation heuristics

8.1 Parallel plans

- Plan steps, serializations and parallel plans
- Forward states and parallel forward distances

Towards better relaxed plans

Why does the greedy algorithm compute low-quality plans?

- ▶ It may apply many operators which are not **goal-directed**.

How can this problem be fixed?

- ▶ **Reaching the goal** of a relaxed planning task is most easily achieved with **forward search**.
- ▶ Analyzing **relevance** of an operator for achieving a goal (or subgoal) is most easily achieved with **backward search**.

Idea: Use a **forward-backward** algorithm that first finds a path to the goal greedily, then prunes it to a relevant subplan.

Relaxed plan steps

How to decide which operators to apply in forward direction?

- ▶ We **avoid** such a decision by applying all applicable operators **simultaneously**.

Definition (plan step)

A **plan step** is a set of operators $\omega = \{\langle \chi_1, e_1 \rangle, \dots, \langle \chi_n, e_n \rangle\}$.

In the **special case of all operators of ω being relaxed**, we further define:

- ▶ Plan step ω is **applicable** in state s iff $s \models \chi_i$ for all $i \in \{1, \dots, n\}$.
- ▶ The **result** of applying ω to s , in symbols $app_\omega(s)$, is defined as the state s' with $on(s') = on(s) \cup \bigcup_{i=1}^n [e_i]_s$.

general semantics for plan steps \rightsquigarrow much later

Applying relaxed plan steps: examples

In all cases, $s = \{a \mapsto 0, b \mapsto 0, c \mapsto 1, d \mapsto 0\}$.

- ▶ $\omega = \{\langle c, a \rangle, \langle \top, b \rangle\}$
- ▶ $\omega = \{\langle c, a \rangle, \langle c, a \triangleright b \rangle\}$
- ▶ $\omega = \{\langle c, a \wedge b \rangle, \langle a, b \triangleright d \rangle\}$
- ▶ $\omega = \{\langle c, a \wedge (b \triangleright d) \rangle, \langle c, b \wedge (a \triangleright d) \rangle\}$

Serializations

Applying a relaxed plan step to a state is related to applying the operators in the step to a state in sequence.

Definition (serialization)

A **serialization** of plan step $\omega = \{o_1^+, \dots, o_n^+\}$ is a sequence $o_{\pi(1)}^+, \dots, o_{\pi(n)}^+$ where π is a permutation of $\{1, \dots, n\}$.

Lemma (conservativeness of plan step semantics)

If ω is a plan step applicable in a state s of a relaxed planning task, then each serialization o_1, \dots, o_n of ω is applicable in s and $app_{o_1, \dots, o_n}(s)$ dominates $app_{\omega}(s)$.

- ▶ Does equality hold for all serializations/some serialization?
- ▶ What if there are no conditional effects?
- ▶ What if we allowed general (unrelaxed) planning tasks?

Parallel plans

Definition (parallel plan)

A **parallel plan** for a relaxed planning task $\langle A, I, O^+, \gamma \rangle$ is a sequence of plan steps $\omega_1, \dots, \omega_n$ of operators in O^+ with:

- ▶ $s_0 := I$
- ▶ For $i = 1, \dots, n$, step ω_i is applicable in s_{i-1} and $s_i := \text{app}_{\omega_i}(s_{i-1})$.
- ▶ $s_n \models \gamma$

Remark: By ordering the operators within each single step arbitrarily, we obtain a (regular, non-parallel) plan.

Forward states, plan steps and sets

Idea: In the forward phase of the heuristic computation,

- ▶ first apply plan step with **all operators applicable initially**,
- ▶ then apply plan step with **all operators applicable then**,
- ▶ and so on.

Definition (forward state, forward plan step, forward set)

Let $\Pi^+ = \langle A, I, O^+, \gamma \rangle$ be a relaxed planning task.

The **n -th forward state**, in symbols s_n^F ($n \in \mathbb{N}_0$),
 the **n -th forward plan step**, in symbols ω_n^F ($n \in \mathbb{N}_1$), and
 the **n -th forward set**, in symbols S_n^F ($n \in \mathbb{N}_0$), are defined as:

- ▶ $s_0^F := I$
- ▶ $\omega_n^F := \{o \in O^+ \mid o \text{ applicable in } s_{n-1}^F\}$ for all $n \in \mathbb{N}_1$
- ▶ $s_n^F := \text{app}_{\omega_n^F}(s_{n-1}^F)$ for all $n \in \mathbb{N}_1$
- ▶ $S_n^F := \text{on}(s_n^F)$ for all $n \in \mathbb{N}_0$

The max heuristic h_{\max}

Definition (parallel forward distance)

The **parallel forward distance** of a relaxed planning task $\langle A, I, O^+, \gamma \rangle$ is the lowest number $n \in \mathbb{N}_0$ such that $s_n^F \models \gamma$, or ∞ if no forward state satisfies γ .

Remark: The parallel forward distance can be computed in polynomial time. (How?)

Definition (max heuristic h_{\max})

Let $\Pi = \langle A, I, O, \gamma \rangle$ be a planning task in positive normal form, and let s be a state of Π .

The **max heuristic** estimate for s , $h_{\max}(s)$, is the parallel forward distance of the relaxed planning task $\langle A, s, O^+, \gamma \rangle$.

Remark: h_{\max} is safe, goal-aware, admissible and consistent. (Why?)

So far, so good...

- ▶ We have seen how systematic computation of forward states leads to an admissible heuristic estimate.
- ▶ However, this estimate is **very coarse**.
- ▶ To improve it, we need to include **backward propagation** of information.

For this purpose, we use so-called **relaxed planning graphs**.

8.2 Relaxed planning graphs

- Introduction
- Construction
- Truth values

AND/OR dags

Definition (AND/OR dag)

An **AND/OR dag** $\langle V, A, type \rangle$ is a directed acyclic graph $\langle V, A \rangle$ with a label function $type: V \rightarrow \{\wedge, \vee\}$ partitioning nodes into **AND nodes** ($type(v) = \wedge$) and **OR nodes** ($type(v) = \vee$).

Note: We draw AND nodes as squares and OR nodes as circles.

Definition (truth values in AND/OR dags)

Let $G = \langle V, A, type \rangle$ be an AND/OR dag, and let $u \in V$ be a node with successor set $\{v_1, \dots, v_k\} \subseteq V$.

The (truth) **value** of u , $val(u)$, is inductively defined as:

- ▶ If $type(u) = \wedge$, then $val(u) = val(v_1) \wedge \dots \wedge val(v_k)$.
- ▶ If $type(u) = \vee$, then $val(u) = val(v_1) \vee \dots \vee val(v_k)$.

Note: No separate base case is needed. (Why not?)

Relaxed planning graphs

Let Π^+ be a relaxed planning task, and let $k \in \mathbb{N}_0$.

The **relaxed planning graph** of Π^+ for depth k , in symbols $RPG_k(\Pi^+)$, is an AND/OR dag that encodes

- ▶ **which propositions** can be made true in k plan steps, and
- ▶ **how** they can be made true.

Its construction is a bit involved, so we present it in stages.

Running example

As a running example, consider the relaxed planning task $\langle A, I, \{o_1, o_2, o_3, o_4\}, \gamma \rangle$ with

$$A = \{a, b, c, d, e, f, g, h\}$$

$$I = \{a \mapsto 1, b \mapsto 0, c \mapsto 1, d \mapsto 1, \\ e \mapsto 0, f \mapsto 0, g \mapsto 0, h \mapsto 0\}$$

$$o_1 = \langle b \vee (c \wedge d), b \wedge ((a \wedge b) \triangleright e) \rangle$$

$$o_2 = \langle \top, f \rangle$$

$$o_3 = \langle f, g \rangle$$

$$o_4 = \langle f, h \rangle$$

$$\gamma = e \wedge (g \wedge h)$$

Running example: forward sets and plan steps

$$I = \{a \mapsto 1, b \mapsto 0, c \mapsto 1, d \mapsto 1, e \mapsto 0, f \mapsto 0, g \mapsto 0, h \mapsto 0\}$$

$$o_1 = \langle b \vee (c \wedge d), b \wedge ((a \wedge b) \triangleright e) \rangle$$

$$o_2 = \langle \top, f \rangle, \quad o_3 = \langle f, g \rangle, \quad o_4 = \langle f, h \rangle$$

$$S_0^F = \{a, c, d\}$$

$$\omega_1^F = \{o_1, o_2\}$$

$$S_1^F = \{a, b, c, d, f\}$$

$$\omega_2^F = \{o_1, o_2, o_3, o_4\}$$

$$S_2^F = \{a, b, c, d, e, f, g, h\}$$

$$\omega_3^F = \omega_2^F$$

$$S_3^F = S_2^F \text{ etc.}$$

Components of relaxed planning graphs

A relaxed planning graph consists of four kinds of components:

- ▶ **Proposition nodes** represent the truth value of propositions after applying a certain number of plan steps.
- ▶ **Idle arcs** represent the fact that state variables, once true, remain true.
- ▶ **Operator subgraphs** represent the possibility and effect of applying a given operator in a given plan step.
- ▶ The **goal subgraph** represents the truth value of the goal condition after k plan steps.

Relaxed planning graph: proposition layers

Let $\Pi^+ = \langle A, I, O^+, \gamma \rangle$ be a relaxed planning task, let $k \in \mathbb{N}_0$.

For each $i \in \{0, \dots, k\}$, $RPG_k(\Pi^+)$ contains one **proposition layer** which consists of:

- ▶ a **proposition node** a^i for each state variable $a \in A$.

Node a^i is an AND node if $i = 0$ and $I \models a$.

Otherwise, it is an OR node.

Relaxed planning graph: proposition layers

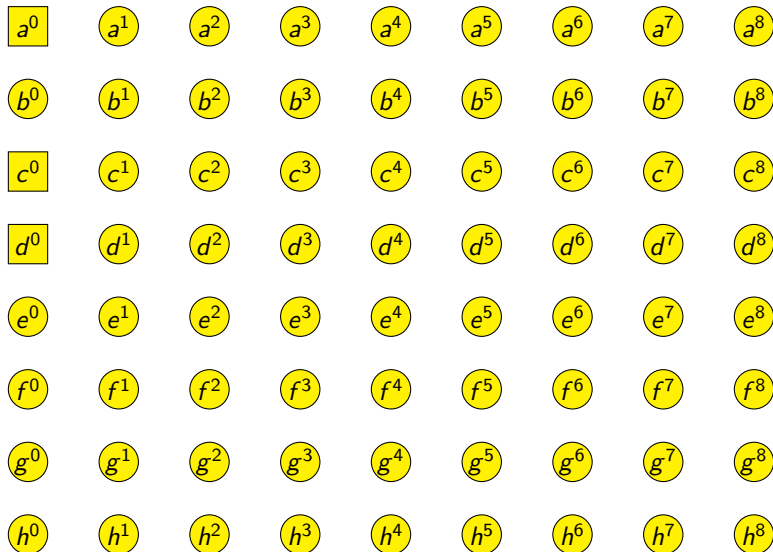

Relaxed planning graph: idle arcs

For each proposition node a^i with $i \in \{1, \dots, k\}$, $RPG_k(\Pi^+)$ contains an arc from a^i to a^{i-1} (idle arcs).

Intuition: If a state variable is true in step i , one of the possible reasons is that it **was already previously true**.

Relaxed planning graph: idle arcs

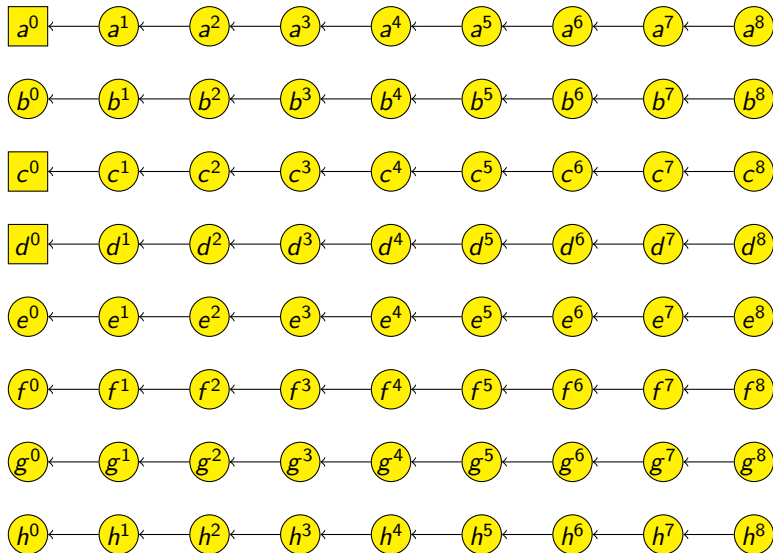

Relaxed planning graph: operator subgraphs

For each $i \in \{1, \dots, k\}$ and each operator $o^+ = \langle \chi, e^+ \rangle \in O^+$, $RPG_k(\Pi^+)$ contains a subgraph called an **operator subgraph** with the following parts:

- ▶ one **formula node** n_φ^i for each formula φ which is a subformula of χ or of some effect condition in e^+ :
 - ▶ If $\varphi = a$ for some atom a , n_φ^i is the proposition node a^{i-1} .
 - ▶ If $\varphi = \top$, n_φ^i is a new AND node without outgoing arcs.
 - ▶ If $\varphi = \perp$, n_φ^i is a new OR node without outgoing arcs.
 - ▶ If $\varphi = (\varphi' \wedge \varphi'')$, n_φ^i is a new AND node with outgoing arcs to $n_{\varphi'}^i$ and $n_{\varphi''}^i$.
 - ▶ If $\varphi = (\varphi' \vee \varphi'')$, n_φ^i is a new OR node with outgoing arcs to $n_{\varphi'}^i$ and $n_{\varphi''}^i$.

Relaxed planning graph: operator subgraphs

For each $i \in \{1, \dots, k\}$ and each operator $o^+ = \langle \chi, e^+ \rangle \in O^+$, $RPG_k(\Pi^+)$ contains a subgraph called an **operator subgraph** with the following parts:

- ▶ for each conditional effect $(\chi' \triangleright a)$ in e^+ , an **effect node** $o_{\chi'}^i$ (an AND node) with outgoing arcs to the precondition formula node n_{χ}^i and effect condition formula node $n_{\chi'}^i$, and incoming arc from proposition node a^i
 - ▶ unconditional effects a (effects which are not part of a conditional effect) are treated the same, except that there is no arc to an effect condition formula node
 - ▶ effects with identical condition (including groups of unconditional effects) share the same effect node
 - ▶ the effect node for unconditional effects is denoted by o^i

Relaxed planning graph: operator subgraphs

Operator subgraph for $o_1 = \langle b \vee (c \wedge d), b \wedge ((a \wedge b) \triangleright e) \rangle$
for layer $i = 1$.

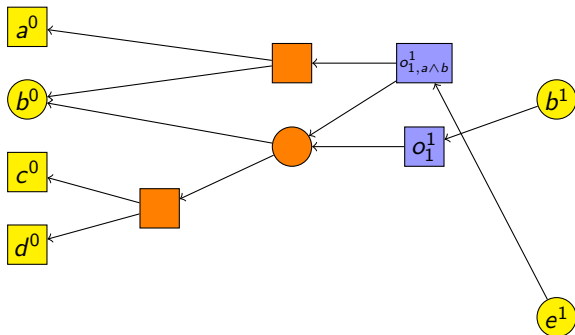

Relaxed planning graph: goal subgraph

$RPG_k(\Pi^+)$ contains a subgraph called a **goal subgraph** with the following parts:

- ▶ one **formula node** n_φ^k for each formula φ which is a subformula of γ :
 - ▶ If $\varphi = a$ for some atom a , n_φ^k is the proposition node a^i .
 - ▶ If $\varphi = \top$, n_φ^k is a new AND node without outgoing arcs.
 - ▶ If $\varphi = \perp$, n_φ^k is a new OR node without outgoing arcs.
 - ▶ If $\varphi = (\varphi' \wedge \varphi'')$, n_φ^k is a new AND node with outgoing arcs to $n_{\varphi'}^k$ and $n_{\varphi''}^k$.
 - ▶ If $\varphi = (\varphi' \vee \varphi'')$, n_φ^k is a new OR node with outgoing arcs to $n_{\varphi'}^k$ and $n_{\varphi''}^k$.

The node n_γ^k is called the **goal node**.

Relaxed planning graph: goal subgraphs

Goal subgraph for $\gamma = e \wedge (g \wedge h)$ and depth $k = 2$:

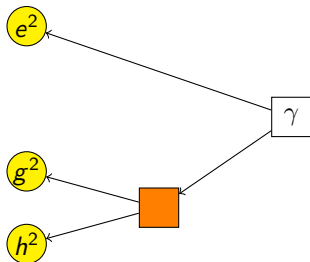

Relaxed planning graph: complete (depth 2)

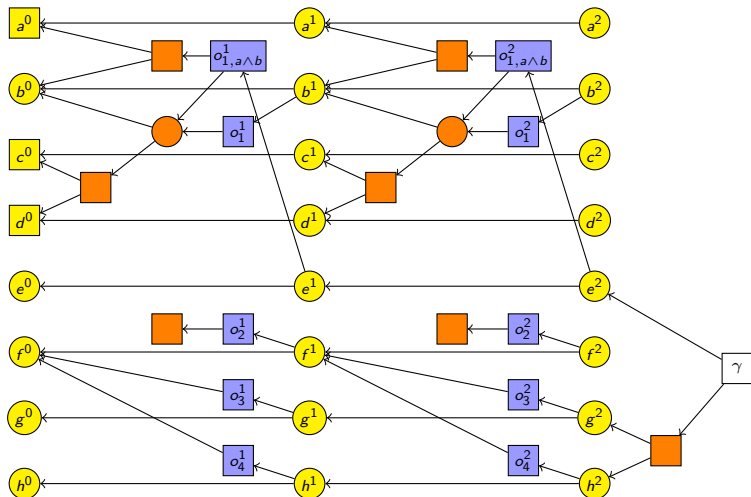

Connection to forward sets and plan steps

Theorem (relaxed planning graph truth values)

Let $\Pi^+ = \langle A, I, O^+, \gamma \rangle$ be a relaxed planning task.

Then the truth values of the nodes of its depth- k relaxed planning graph $RPG_k(\Pi^+)$ relate to the forward sets and forward plan steps of Π^+ as follows:

▶ *Proposition nodes:*

For all $a \in A$ and $i \in \{0, \dots, k\}$, $\text{val}(a^i) = 1$ iff $a \in S_i^F$.

▶ *(Unconditional) effect nodes:*

For all $o \in O^+$ and $i \in \{1, \dots, k\}$, $\text{val}(o^i) = 1$ iff $o \in \omega_i^F$.

▶ *Goal nodes:*

$\text{val}(n_\gamma^k) = 1$ iff the parallel forward distance of Π^+ is at most k .

(We omit the straight-forward proof.)

Computing the node truth values

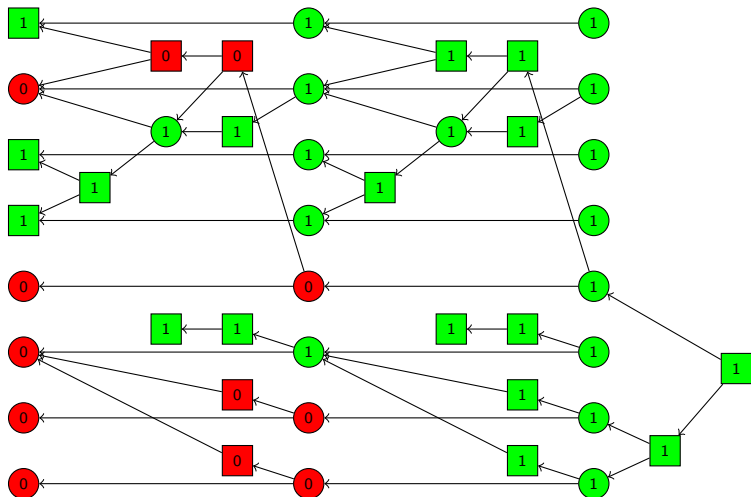

Relaxed planning graphs for STRIPS

Remark: Relaxed planning graphs have historically been defined for STRIPS tasks only. In this case, we can simplify:

- ▶ **Only one effect node per operator:** STRIPS does not have conditional effects.
 - ▶ Because each operator has only one effect node, effect nodes are called **operator nodes** in relaxed planning graphs for STRIPS.
- ▶ **No goal nodes:** The test whether all goals are reached is done by the algorithm that evaluates the AND/OR dag.
- ▶ **No formula nodes:** Operator nodes are directly connected to their preconditions.

↪ Relaxed planning graphs for STRIPS are **layered** digraphs and only have **proposition and operator nodes**.

8.3 Relaxation heuristics

- Generic template for relaxation heuristics
- The max heuristic h_{\max}
- The additive heuristic h_{add}
- The set-additive heuristic h_{sa}
- Incremental computation
- The FF heuristic h_{FF}
- Comparison & relaxation heuristics in practice

Computing parallel forward distances from RPGs

So far, relaxed planning graphs offer us a way to compute parallel forward distances:

Parallel forward distances from relaxed planning graphs

def *parallel-forward-distance*(Π^+):

Let A be the set of state variables of Π^+ .

for $k \in \{0, 1, 2, \dots\}$:

$rpg := RPG_k(\Pi^+)$

Evaluate truth values for rpg .

if goal node of rpg has value 1:

return k

else if $k = |A|$:

return ∞

Remarks on the algorithm

- ▶ The relaxed planning graph for depth $k \geq 1$ can be built **incrementally** from the one for depth $k - 1$:
 - ▶ Add new layer k .
 - ▶ Move goal subgraph from layer $k - 1$ to layer k .
- ▶ Similarly, all truth values up to layer $k - 1$ can be reused.
- ▶ Thus, overall computation with maximal depth m requires time $O(\|RPG_m(\Pi^+)\|) = O((m + 1) \cdot \|\Pi^+\|)$.
- ▶ This is not a very efficient way of computing parallel forward distances (and wouldn't be used in practice).
- ▶ However, it allows computing **additional information** for the relaxed planning graph nodes along the way, which can be used for heuristic estimates.

Generic relaxed planning graph heuristics

Computing heuristics from relaxed planning graphs

```

def generic-rpg-heuristic( $\langle A, I, O, \gamma \rangle, s$ ):
     $\Pi^+ := \langle A, s, O^+, \gamma \rangle$ 
    for  $k \in \{0, 1, 2, \dots\}$ :
         $rpg := RPG_k(\Pi^+)$ 
        Evaluate truth values for  $rpg$ .
        if goal node of  $rpg$  has value 1:
            Annotate true nodes of  $rpg$ .
            if termination criterion is true:
                return heuristic value from annotations
        else if  $k = |A|$ :
            return  $\infty$ 
  
```

↪ generic template for heuristic functions

↪ to get concrete heuristic: fill in highlighted parts

Concrete examples for the generic heuristic

Many planning heuristics fit the generic template:

- ▶ **additive heuristic** h_{add} (Bonet, Loerincs & Geffner, 1997)
- ▶ **max heuristic** h_{max} (Bonet & Geffner, 1999)
- ▶ **FF heuristic** h_{FF} (Hoffmann & Nebel, 2001)
- ▶ **cost-sharing heuristic** h_{cs} (Mirkis & Domshlak, 2007)
 - ▶ not covered in this course
- ▶ **set-additive heuristic** h_{sa} (Keyder & Geffner, 2008)

Remarks:

- ▶ For all these heuristics, equivalent definitions that don't refer to relaxed planning graphs are possible.
- ▶ Historically, such equivalent definitions have mostly been used for h_{max} , h_{add} and h_{sa} .
- ▶ For those heuristics, the most efficient implementations do not use relaxed planning graphs explicitly.

Forward cost heuristics

- ▶ The simplest relaxed planning graph heuristics are **forward cost heuristics**.
- ▶ Examples: h_{\max} , h_{add}
- ▶ Here, node annotations are **cost values** (natural numbers).
- ▶ The cost of a node estimates how expensive (in terms of required operators) it is to make this node true.

Forward cost heuristics: fitting the template

Forward cost heuristics

Computing annotations:

- ▶ Propagate cost values bottom-up using a combination rule for OR nodes and a combination rule for AND nodes.
- ▶ At effect nodes, add 1 after applying combination rule.

Termination criterion:

- ▶ **stability**: terminate if cost for proposition node a^k equals cost for a^{k-1} for all true propositions a in layer k

Heuristic value:

- ▶ The heuristic value is the cost of the goal node.
- ▶ Different forward cost heuristics only differ in their choice of combination rules.

The max heuristic h_{\max} (again)

Forward cost heuristics: max heuristic h_{\max}

Combination rule for AND nodes:

- ▶ $cost(u) = \max(\{cost(v_1), \dots, cost(v_k)\})$
(with $\max(\emptyset) := 0$)

Combination rule for OR nodes:

- ▶ $cost(u) = \min(\{cost(v_1), \dots, cost(v_k)\})$

In both cases, $\{v_1, \dots, v_k\}$ is the set of true successors of u .

Intuition:

- ▶ **AND rule:** If we have to achieve several conditions, estimate this by the **most expensive** cost.
- ▶ **OR rule:** If we have a choice how to achieve a condition, pick the **cheapest** possibility.

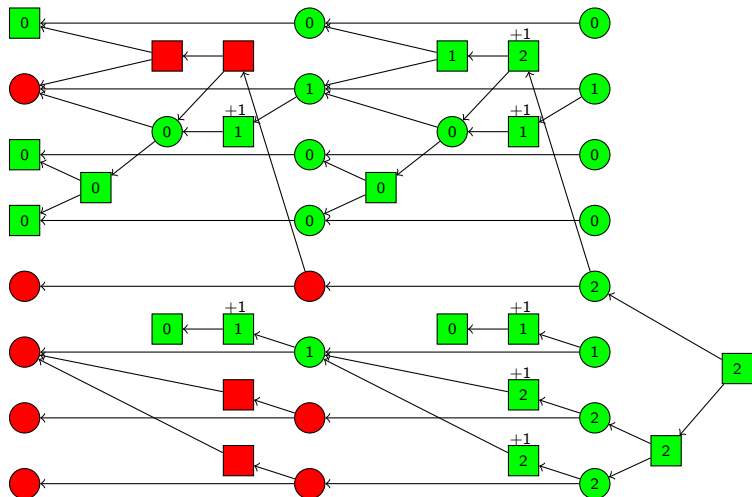
Running example: h_{max} 

Remarks on h_{\max}

- ▶ The definition of h_{\max} as a forward cost heuristic is equivalent to our earlier definition in this chapter.
- ▶ Unlike the earlier definition, it generalizes to an extension where every operator has an associated non-negative **cost** (rather than all operators having cost 1).
- ▶ In the case without costs (and only then), it is easy to prove that the goal node has the same cost in all graphs $RPG_k(\Pi^+)$ where it is true. (Namely, the cost is equal to the lowest value of k for which the goal node is true.)
- ▶ We can thus terminate the computation as soon as the goal becomes true, without waiting for stability.
- ▶ The same is **not true** for other forward-propagating heuristics (h_{add} , h_{CS} , h_{SA}).

The additive heuristic

Forward cost heuristics: additive heuristic h_{add}

Combination rule for AND nodes:

- ▶ $cost(u) = cost(v_1) + \dots + cost(v_k)$
(with $\sum(\emptyset) := 0$)

Combination rule for OR nodes:

- ▶ $cost(u) = \min(\{cost(v_1), \dots, cost(v_k)\})$

In both cases, $\{v_1, \dots, v_k\}$ is the set of true successors of u .

Intuition:

- ▶ **AND rule:** If we have to achieve several conditions, estimate this by the cost of achieving **each in isolation**.
- ▶ **OR rule:** If we have a choice how to achieve a condition, pick the **cheapest** possibility.

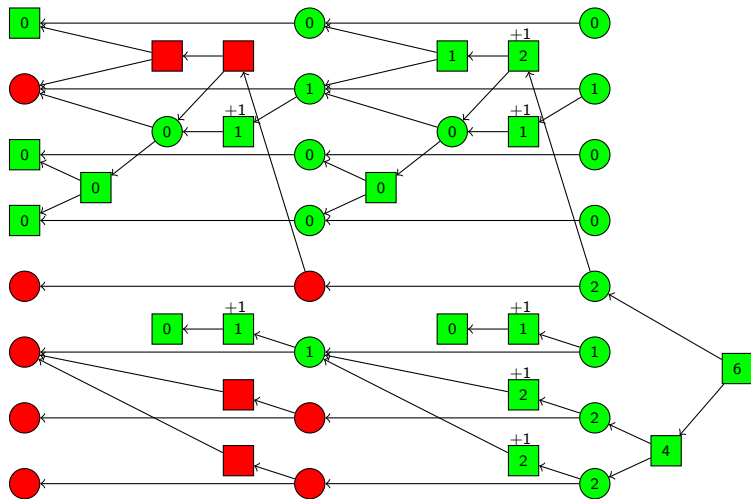
Running example: h_{add} 

Remarks on h_{add}

- ▶ It is important to test for stability in computing h_{add} !
(The reason for this is that, unlike h_{max} , cost values of true propositions can **decrease** from layer to layer.)
- ▶ Stability is achieved after layer $|A|$ in the worst case.
- ▶ h_{add} is **safe** and **goal-aware**.
- ▶ Unlike h_{max} , h_{add} is a **very informative** heuristic in many planning domains.
- ▶ The price for this is that it is **not admissible** (and hence also **not consistent**), so not suitable for optimal planning.
- ▶ In fact, it **almost always** overestimates the h^+ value because it does not take **positive interactions** into account.

The set-additive heuristic

- ▶ We now discuss a refinement of the additive heuristic called the **set-additive heuristic** h_{sa} .
- ▶ The set-additive heuristic addresses the problem that h_{add} does not take positive interactions into account.
- ▶ Like h_{max} and h_{add} , h_{sa} is calculated through **forward propagation** of node annotations.
- ▶ However, the node annotations are not cost values, but **sets of operators** (kind of).
- ▶ The idea is that by taking **set unions** instead of **adding costs**, operators needed only once are **counted only once**.

Disclaimer: There are some quite subtle differences between the h_{sa} heuristic as we describe it here and the “real” heuristic of Keyder & Geffner. We do not want to discuss this in detail, but please note that such differences exist.

Operators needed several times

- ▶ The original h_{sa} heuristic as described in the literature is defined for STRIPS tasks and propagates **sets of operators**.
- ▶ This is fine because in relaxed STRIPS tasks, each operator **need only be applied once**.
- ▶ The same is **not true in general**: in our running example, operator o_1 must be applied twice in the relaxed plan.
- ▶ In general, it only makes sense to apply an operator again in a relaxed planning task if a **previously unsatisfied effect condition** has been made true.
- ▶ For this reason, we keep track of **operator/effect condition pairs** rather than just plain operators.

Set-additive heuristic: fitting the template

The set-additive heuristic h_{sa}

Computing annotations:

- ▶ Annotations are **sets of operator/effect condition pairs**, computed bottom-up.

Combination rule for AND nodes:

- ▶ $ann(u) = ann(v_1) \cup \dots \cup ann(v_k)$ (with $\bigcup(\emptyset) := \emptyset$)

Combination rule for OR nodes:

- ▶ $ann(u) = ann(v_i)$ for some v_i minimizing $|ann(v_i)|$
In case of several minimizers, use any tie-breaking rule.

In both cases, $\{v_1, \dots, v_k\}$ is the set of true successors of u .

...

Set-additive heuristic: fitting the template (ctd.)

The set-additive heuristic h_{sa} (ctd.)

Computing annotations:

▶ ...

At **effect nodes**, add the corresponding operator/effect condition pair to the set after applying combination rule. (Effect nodes for unconditional effects are represented just by the operator, without a condition.)

Termination criterion:

- ▶ **stability**: terminate if set for proposition node a^k has same cardinality as for a^{k-1} for all true propositions a in layer k

Heuristic value:

- ▶ The heuristic value is the **set cardinality** of the goal node annotation.

Remarks on h_{sa}

- ▶ The same remarks for stability as for h_{add} apply.
- ▶ Like h_{add} , h_{sa} is **safe** and **goal-aware**, but neither **admissible** nor **consistent**.
- ▶ h_{sa} is generally **better informed** than h_{add} , but significantly more expensive to compute.
- ▶ The h_{sa} value depends on the tie-breaking rule used, so h_{sa} is **not well-defined** without specifying the tie-breaking rule.
- ▶ The operators contained in the goal node annotation, suitably ordered, define a **relaxed plan** for the task.
 - ▶ Operators mentioned several times in the annotation must be added as many times in the relaxed plan.

Incremental computation of forward heuristics

One nice property of forward-propagating heuristics is that they allow **incremental computation**:

- ▶ when evaluating several states in sequence which only differ in a few state variables, can
 - ▶ **start computation from previous results** and
 - ▶ keep track only of **what needs to be recomputed**
- ▶ typical use case: **depth-first** style searches (e. g., IDA*)
- ▶ rarely exploited in practice

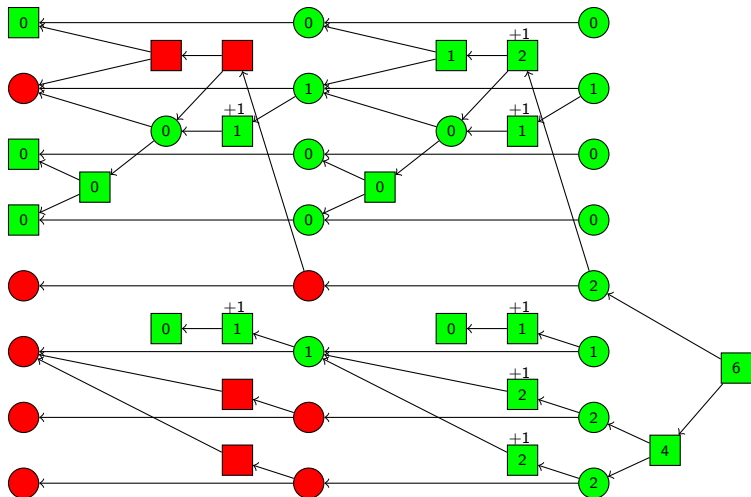
Incremental computation example: h_{add} Result for $\{a \mapsto 1, b \mapsto 0, c \mapsto 1, d \mapsto 1, e \mapsto 0, f \mapsto 0, g \mapsto 0, h \mapsto 0\}$ 

Incremental computation example: h_{add}

Recompute outdated values.

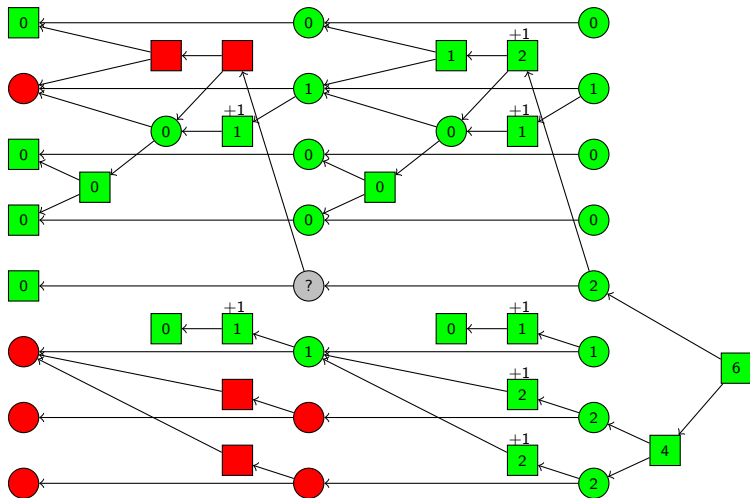

Incremental computation example: h_{add}

Recompute outdated values.

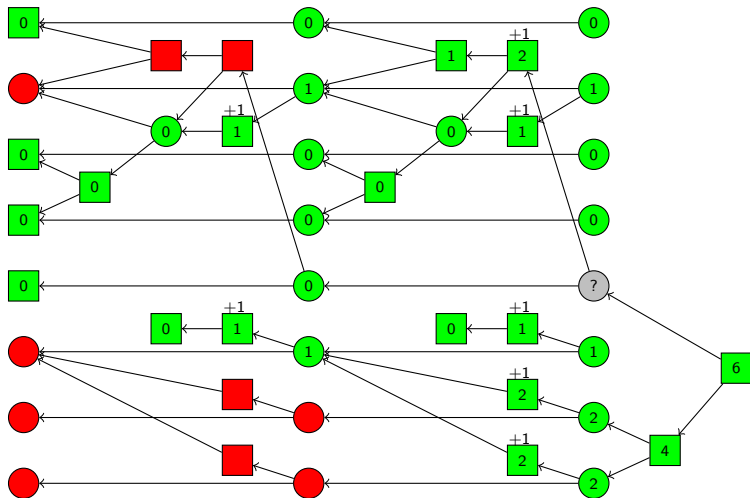

Incremental computation example: h_{add}

Recompute outdated values.

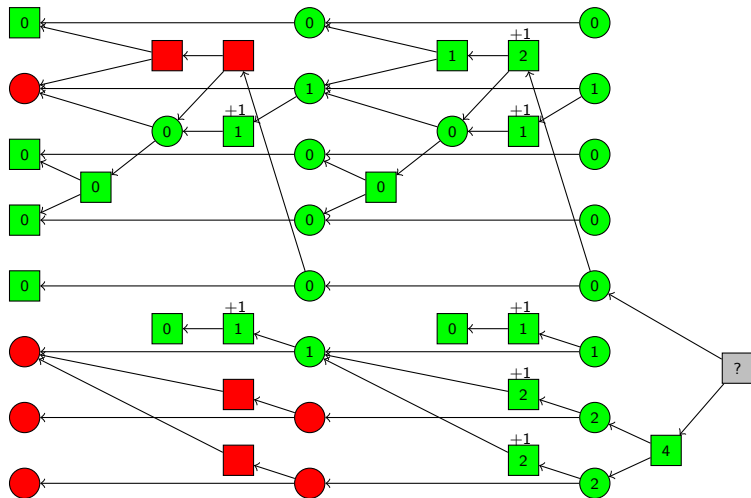

Incremental computation example: h_{add}

Recompute outdated values.

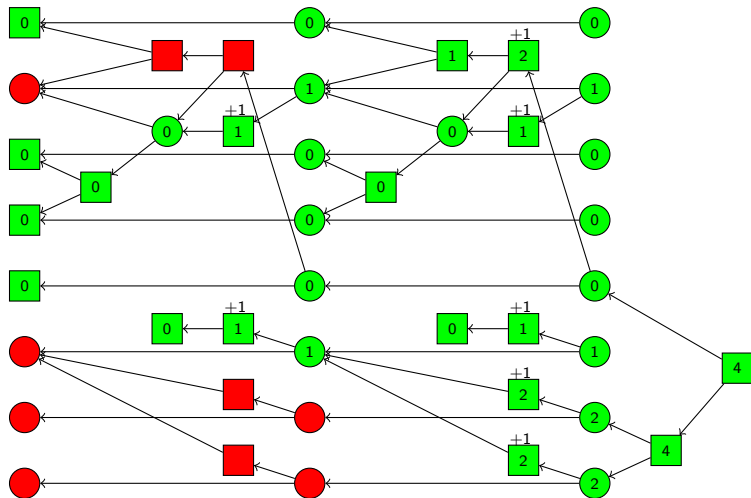

Heuristic estimate h_{FF}

- ▶ h_{sa} is more expensive to compute than the other forward propagating heuristics because we must propagate **sets**.
- ▶ It is possible to get the same advantage over h_{add} combined with efficient propagation.
- ▶ Key idea of h_{FF} : perform a **backward propagation** that selects a sufficient subset of nodes to make the goal true (called a **solution graph** in AND/OR dag literature).
- ▶ The resulting heuristic is almost as informative as h_{sa} , yet computable as quickly as h_{add} .

Note: Our presentation inverts the historical order.

The set-additive heuristic was defined **after** the FF heuristic (sacrificing speed for even higher informativeness).

FF heuristic: fitting the template

The FF heuristic h_{FF}

Computing annotations:

- ▶ Annotations are **Boolean values**, computed top-down.

A node is **marked** when its annotation is set to 1 and **unmarked** if it is set to 0. Initially, the goal node is marked, and all other nodes are unmarked.

We say that a true AND node is **justified** if all its true successors are marked, and that a true OR node is **justified** if at least one of its true successors is marked.

...

FF heuristic: fitting the template (ctd.)

The FF heuristic h_{FF} (ctd.)

Computing annotations:

► ...

Apply these rules until **all marked nodes are justified**:

1. Mark all true successors of a marked unjustified AND node.
2. Mark the true successor of a marked unjustified OR node with only one true successor.
3. Mark a true successor of a marked unjustified OR node connected via an idle arc.
4. Mark any true successor of a marked unjustified OR node.

The rules are given in priority order: earlier rules are preferred if applicable.

FF heuristic: fitting the template (ctd.)

The FF heuristic h_{FF} (ctd.)

Termination criterion:

- ▶ **Always terminate** at first layer where goal node is true.

Heuristic value:

- ▶ The heuristic value is the **number of operator/effect condition pairs** for which **at least one** effect node is marked.

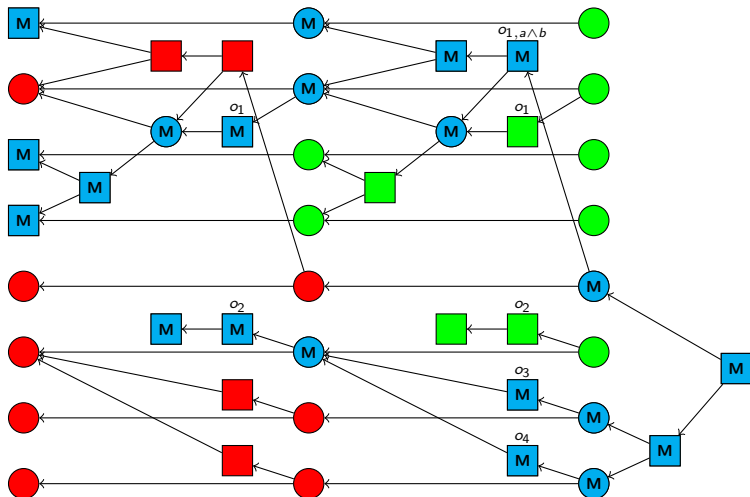
Running example: h_{FF} 

Remarks on h_{FF}

- ▶ Like h_{add} and h_{sa} , h_{FF} is **safe** and **goal-aware**, but neither **admissible** nor **consistent**.
- ▶ Its informativeness can be expected to be slightly worse than for h_{sa} , but is usually not far off.
- ▶ Unlike h_{sa} , h_{FF} can be computed in **linear time**.
- ▶ Similar to h_{sa} , the operators corresponding to the marked operator/effect condition pairs define a **relaxed plan**.
- ▶ Similar to h_{sa} , the h_{FF} value depends on tie-breaking when the marking rules allow several possible choices, so h_{FF} is **not well-defined** without specifying the tie-breaking rule.
 - ▶ The implementation in FF uses additional rules of thumb to try to reduce the size of the generated relaxed plan.

Comparison of relaxation heuristics

Theorem (relationship between relaxation heuristics)

Let s be a state of planning task $\langle A, I, O, \gamma \rangle$. Then:

- ▶ $h_{max}(s) \leq h^+(s) \leq h^*(s)$
- ▶ $h_{max}(s) \leq h^+(s) \leq h_{sa}(s) \leq h_{add}(s)$
- ▶ $h_{max}(s) \leq h^+(s) \leq h_{FF}(s) \leq h_{add}(s)$
- ▶ h^* , h_{FF} and h_{sa} are pairwise incomparable
- ▶ h^* and h_{add} are incomparable

Moreover, h^+ , h_{max} , h_{add} , h_{sa} and h_{FF} assign ∞ to the same set of states.

Note: For **inadmissible** heuristics, dominance is in general neither desirable nor undesirable. For relaxation heuristics, the objective is usually to get as close to h^+ as possible.

Relaxation heuristics in practice: HSP

Example (HSP)

HSP (Bonet & Geffner) was one of the four top performers at the 1st International Planning Competition (IPC-1998).

Key ideas:

- ▶ **hill climbing** search using h_{add}
- ▶ on **plateaus**, keep going for a number of iterations, then restart
- ▶ use a closed list during exploration of plateaus

Literature: Bonet, Loerincs & Geffner (1997), Bonet & Geffner (2001)

Relaxation heuristics in practice: FF

Example (FF)

FF (Hoffmann & Nebel) won the 2nd International Planning Competition (IPC-2000).

Key ideas:

- ▶ **enforced hill-climbing** search using h_{FF}
- ▶ **helpful action pruning**: in each search node, only consider successors from operators that add one of the atoms marked in proposition layer 1
- ▶ **goal ordering**: in certain cases, FF recognizes and exploits that certain subgoals should be solved one after the other

If the main search fails, FF performs a greedy best-first search using h_{FF} without helpful action pruning or goal ordering.

Literature: Hoffmann & Nebel (2001), Hoffmann (2005)

Relaxation heuristics in practice: Fast Downward

Example (Fast Downward)

Fast Downward (Helmert & Richter) won the satisficing track of the 4th International Planning Competition (IPC-2004).

Key ideas:

- ▶ **greedy best-first search** using h_{FF} and **causal graph heuristic** (not relaxation-based)
- ▶ search enhancements:
 - ▶ multi-heuristic best-first search
 - ▶ deferred evaluation of heuristic estimates
 - ▶ preferred operators (similar to FF's helpful actions)

Literature: Helmert (2006)

Relaxation heuristics in practice: SGPlan

Example (SGPlan)

SGPlan (Wah, Hsu, Chen & Huang) won the satisficing track of the 5th International Planning Competition (IPC-2006).

Key ideas:

- ▶ **FF**
- ▶ **problem decomposition** techniques
- ▶ **domain-specific techniques**

Literature: Chen, Wah & Hsu (2006)

Relaxation heuristics in practice: LAMA

Example (LAMA)

LAMA (Richter & Westphal) won the satisficing track of the 6th International Planning Competition (IPC-2008).

Key ideas:

- ▶ **Fast Downward**
- ▶ **landmark pseudo-heuristic** instead of causal graph heuristic (“somewhat” relaxation-based)
- ▶ anytime variant of **Weighted A*** instead of greedy best-first search

Literature: Richter, Helmert & Westphal (2008),
Richter & Westphal (2010)

Summary

- ▶ **Relaxed planning graphs** are **AND/OR dags**. They encode which propositions can be made true in Π^+ and how.
 - ▶ They are closely related to **forward sets** and **forward plan steps**, based on the notion of **parallel relaxed plans**.
 - ▶ They can be **constructed and evaluated efficiently**, in time $O((m + 1)\|\Pi^+\|)$ for planning task Π and depth m .
- ▶ By annotating RPG nodes with appropriate information, we can compute many useful heuristics.
- ▶ Examples: the **max** heuristic h_{\max} , **additive** heuristic h_{add} , **set-additive** heuristic h_{sa} and **FF** heuristic h_{FF}
 - ▶ Of these, only h_{\max} is admissible (but not very accurate).
 - ▶ The others are much more informative. The set-additive heuristic is the most sophisticated one.
 - ▶ The FF heuristic is often similarly informative. It offers a good trade-off between accuracy and computation time.