

Principles of AI Planning

8. Planning as search: relaxation heuristics

Albert-Ludwigs-Universität Freiburg



UNI
FREIBURG

Bernhard Nebel and Robert Mattmüller

November 27th, 2019



Parallel plans

Parallel
plans

Plan steps

Forward distances

Relaxed
planning
graphs

Relaxation
heuristics

Summary



Why does the greedy algorithm compute low-quality plans?

- It may apply many operators which are not **goal-directed**.

How can this problem be fixed?

- **Reaching the goal** of a relaxed planning task is most easily achieved with **forward search**.
- Analyzing **relevance** of an operator for achieving a goal (or subgoal) is most easily achieved with **backward search**.

Idea: Use a **forward-backward** algorithm that first finds a path to the goal greedily, then prunes it to a relevant subplan.

Parallel plans

Plan steps

Forward distances

Relaxed planning graphs

Relaxation heuristics

Summary



How to decide which operators to apply in forward direction?

- We **avoid** such a decision by applying all applicable operators **simultaneously**.

Definition (plan step)

A **plan step** is a set of operators $\omega = \{\langle \chi_1, e_1 \rangle, \dots, \langle \chi_n, e_n \rangle\}$.

In the **special case of all operators of ω being relaxed**, we further define:

- Plan step ω is **applicable** in state s iff $s \models \chi_i$ for all $i \in \{1, \dots, n\}$.
- The **result** of applying ω to s , in symbols $app_\omega(s)$, is defined as the state s' with $on(s') = on(s) \cup \bigcup_{i=1}^n [e_i]_s$.

general semantics for plan steps \rightsquigarrow much later

Parallel plans

Plan steps

Forward distances

Relaxed planning graphs

Relaxation heuristics

Summary

Applying relaxed plan steps: examples



In all cases, $s = \{a \mapsto 0, b \mapsto 0, c \mapsto 1, d \mapsto 0\}$.

- $\omega = \{\langle c, a \rangle, \langle \top, b \rangle\}$
- $\omega = \{\langle c, a \rangle, \langle c, a \triangleright b \rangle\}$
- $\omega = \{\langle c, a \wedge b \rangle, \langle a, b \triangleright d \rangle\}$
- $\omega = \{\langle c, a \wedge (b \triangleright d) \rangle, \langle c, b \wedge (a \triangleright d) \rangle\}$

Parallel
plans

Plan steps

Forward distances

Relaxed
planning
graphs

Relaxation
heuristics

Summary

Applying a relaxed plan step to a state is related to applying the operators in the step to a state in sequence.

Definition (serialization)

A **serialization** of plan step $\omega = \{o_1^+, \dots, o_n^+\}$ is a sequence $o_{\pi(1)}^+, \dots, o_{\pi(n)}^+$ where π is a permutation of $\{1, \dots, n\}$.

Lemma (conservativeness of plan step semantics)

If ω is a plan step applicable in a state s of a relaxed planning task, then each serialization o_1, \dots, o_n of ω is applicable in s and $app_{o_1, \dots, o_n}(s)$ dominates $app_{\omega}(s)$.

- Does equality hold for all/some serialization(s)?
- What if there are no conditional effects?
- What if we allowed general (unrelaxed) planning tasks?

Parallel plans

Plan steps

Forward distances

Relaxed planning graphs

Relaxation heuristics

Summary



Definition (parallel plan)

A **parallel plan** for a relaxed planning task $\langle A, I, O^+, \gamma \rangle$ is a sequence of plan steps $\omega_1, \dots, \omega_n$ of operators in O^+ with:

- $s_0 := I$
- For $i = 1, \dots, n$, step ω_i is applicable in s_{i-1} and $s_i := \text{app}_{\omega_i}(s_{i-1})$.
- $s_n \models \gamma$

Remark: By ordering the operators within each single step arbitrarily, we obtain a (regular, non-parallel) plan.

Parallel plans

Plan steps

Forward distances

Relaxed planning graphs

Relaxation heuristics

Summary



Idea: In the forward phase of the heuristic computation,

- 1 apply plan step with **all operators applicable initially**,
- 2 apply plan step with **all operators applicable then**,
- 3 and so on.

Definition (forward state/plan step/set)

Let $\Pi^+ = \langle A, I, O^+, \gamma \rangle$ be a relaxed planning task.

The **n -th forward state**, in symbols s_n^F ($n \in \mathbb{N}_0$),
the **n -th forward plan step**, in symbols ω_n^F ($n \in \mathbb{N}_1$), and
the **n -th forward set**, in symbols S_n^F ($n \in \mathbb{N}_0$), are defined as:

- $s_0^F := I$
- $\omega_n^F := \{o \in O^+ \mid o \text{ applicable in } s_{n-1}^F\}$ for all $n \in \mathbb{N}_1$
- $s_n^F := \text{app}_{\omega_n^F}(s_{n-1}^F)$ for all $n \in \mathbb{N}_1$
- $S_n^F := \text{on}(s_n^F)$ for all $n \in \mathbb{N}_0$

Parallel
plans

Plan steps

Forward distances

Relaxed
planning
graphs

Relaxation
heuristics

Summary



Definition (parallel forward distance)

The **parallel forward distance** of a relaxed planning task $\langle A, I, O^+, \gamma \rangle$ is the lowest number $n \in \mathbb{N}_0$ such that $s_n^F \models \gamma$, or ∞ if no forward state satisfies γ .

Remark: The parallel forward distance can be computed in polynomial time. (How?)

Definition (max heuristic h_{\max})

Let $\Pi = \langle A, I, O, \gamma \rangle$ be a planning task in positive normal form, and let s be a state of Π .

The **max heuristic** estimate for s , $h_{\max}(s)$, is the parallel forward distance of the relaxed planning task $\langle A, s, O^+, \gamma \rangle$.

Remark: h_{\max} is safe, goal-aware, admissible and consistent. (Why?)

Parallel plans

Plan steps

Forward distances

Relaxed planning graphs

Relaxation heuristics

Summary



- We have seen how systematic computation of forward states leads to an admissible heuristic estimate.
- However, this estimate is **very coarse**.
- To improve it, we need to include **backward propagation** of information.

For this purpose, we use so-called **relaxed planning graphs**.

Parallel plans

Plan steps

Forward distances

Relaxed planning graphs

Relaxation heuristics

Summary



Relaxed planning graphs

Parallel
plans

Relaxed
planning
graphs

Introduction
Construction
Truth values

Relaxation
heuristics

Summary

Definition (AND/OR dag)

An **AND/OR dag** $\langle V, A, type \rangle$ is a directed acyclic graph $\langle V, A \rangle$ with a label function $type : V \rightarrow \{\wedge, \vee\}$ partitioning nodes into **AND nodes** ($type(v) = \wedge$) and **OR nodes** ($type(v) = \vee$).

Note: AND nodes drawn as squares, OR nodes as circles.

Definition (truth values in AND/OR dags)

Let $G = \langle V, A, type \rangle$ be an AND/OR dag, and let $u \in V$ be a node with successor set $\{v_1, \dots, v_k\} \subseteq V$.

The (truth) **value** of u , $val(u)$, is inductively defined as:

- If $type(u) = \wedge$, then $val(u) = val(v_1) \wedge \dots \wedge val(v_k)$.
- If $type(u) = \vee$, then $val(u) = val(v_1) \vee \dots \vee val(v_k)$.

Parallel plans

Relaxed planning graphs

Introduction
Construction
Truth values

Relaxation heuristics

Summary



Parallel
plans

Relaxed
planning
graphs

Introduction
Construction
Truth values

Relaxation
heuristics

Summary

Let Π^+ be a relaxed planning task, and let $k \in \mathbb{N}_0$.

The **relaxed planning graph** of Π^+ for depth k , in symbols $RPG_k(\Pi^+)$, is an AND/OR dag that encodes

- **which propositions** can be made true in k plan steps, and
- **how** they can be made true.

Its construction is a bit involved, so we present it in stages.

As a running example, consider the relaxed planning task $\langle A, I, \{o_1, o_2, o_3, o_4\}, \gamma \rangle$ with

$$A = \{a, b, c, d, e, f, g, h\}$$

$$I = \{a \mapsto 1, b \mapsto 0, c \mapsto 1, d \mapsto 1, \\ e \mapsto 0, f \mapsto 0, g \mapsto 0, h \mapsto 0\}$$

$$o_1 = \langle b \vee (c \wedge d), b \wedge ((a \wedge b) \triangleright e) \rangle$$

$$o_2 = \langle \top, f \rangle$$

$$o_3 = \langle f, g \rangle$$

$$o_4 = \langle f, h \rangle$$

$$\gamma = e \wedge (g \wedge h)$$

Parallel
plans

Relaxed
planning
graphs

Introduction
Construction
Truth values

Relaxation
heuristics

Summary



$$I = \{a \mapsto 1, b \mapsto 0, c \mapsto 1, d \mapsto 1, e \mapsto 0, f \mapsto 0, g \mapsto 0, h \mapsto 0\}$$

$$o_1 = \langle b \vee (c \wedge d), b \wedge ((a \wedge b) \triangleright e) \rangle$$

$$o_2 = \langle \top, f \rangle, \quad o_3 = \langle f, g \rangle, \quad o_4 = \langle f, h \rangle$$

$$S_0^F = \{a, c, d\}$$

$$\omega_1^F = \{o_1, o_2\}$$

$$S_1^F = \{a, b, c, d, f\}$$

$$\omega_2^F = \{o_1, o_2, o_3, o_4\}$$

$$S_2^F = \{a, b, c, d, e, f, g, h\}$$

$$\omega_3^F = \omega_2^F$$

$$S_3^F = S_2^F \text{ etc.}$$

Parallel
plans

Relaxed
planning
graphs

Introduction
Construction
Truth values

Relaxation
heuristics

Summary



A relaxed planning graph consists of four kinds of components:

- **Proposition nodes** represent the truth value of propositions after applying a certain number of plan steps.
- **Idle arcs** represent the fact that state variables, once true, remain true.
- **Operator subgraphs** represent the possibility and effect of applying a given operator in a given plan step.
- The **goal subgraph** represents the truth value of the goal condition after k plan steps.

Parallel plans

Relaxed planning graphs

Introduction
Construction
Truth values

Relaxation heuristics

Summary



Let $\Pi^+ = \langle A, I, O^+, \gamma \rangle$ be a relaxed planning task, let $k \in \mathbb{N}_0$.

For each $i \in \{0, \dots, k\}$, $RPG_k(\Pi^+)$ contains one **proposition layer** which consists of:

- a **proposition node** a^i for each state variable $a \in A$.

Node a^i is an AND node if $i = 0$ and $I \models a$.

Otherwise, it is an OR node.

Parallel
plans

Relaxed
planning
graphs

Introduction
Construction
Truth values

Relaxation
heuristics

Summary

Relaxed planning graph: proposition layers

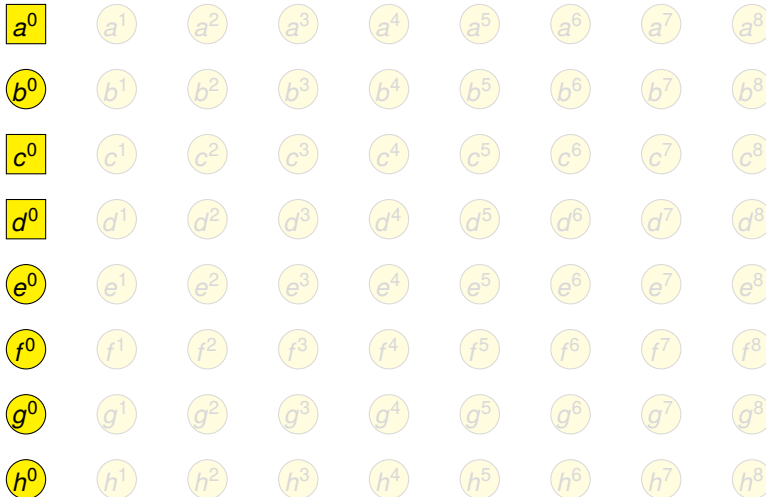

Parallel plans

Relaxed planning graphs

Introduction
Construction
Truth values

Relaxation heuristics

Summary

Relaxed planning graph: proposition layers

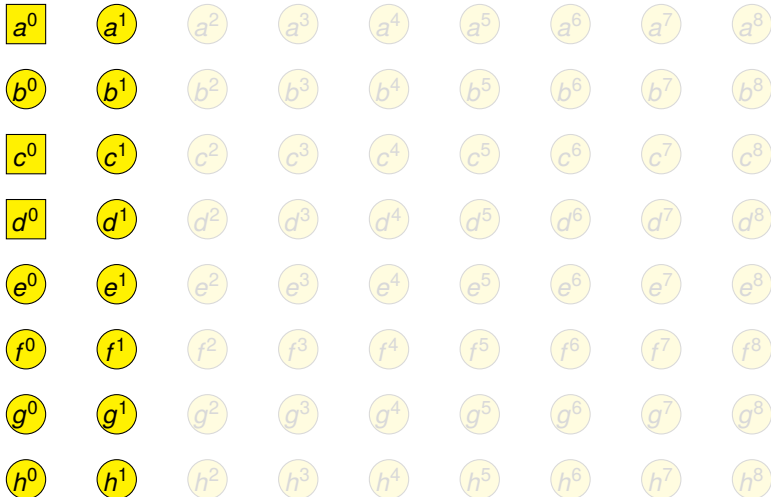

Parallel plans

Relaxed planning graphs

Introduction
Construction
Truth values

Relaxation heuristics

Summary

Relaxed planning graph: proposition layers

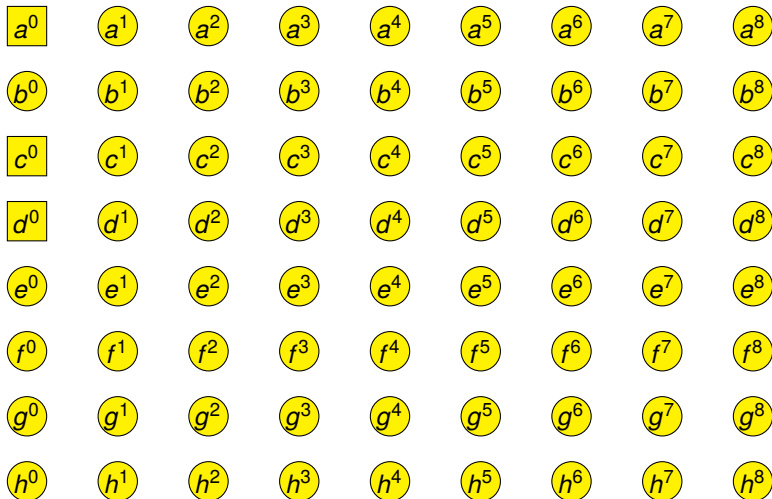

Parallel plans

Relaxed planning graphs

Introduction
Construction
Truth values

Relaxation heuristics

Summary



For each proposition node a^i with $i \in \{1, \dots, k\}$, $RPG_k(\Pi^+)$ contains an arc from a^i to a^{i-1} (**idle arcs**).

Intuition: If a state variable is true in step i , one of the possible reasons is that it **was already previously true**.

Parallel
plans

Relaxed
planning
graphs

Introduction
Construction
Truth values

Relaxation
heuristics

Summary

Relaxed planning graph: idle arcs

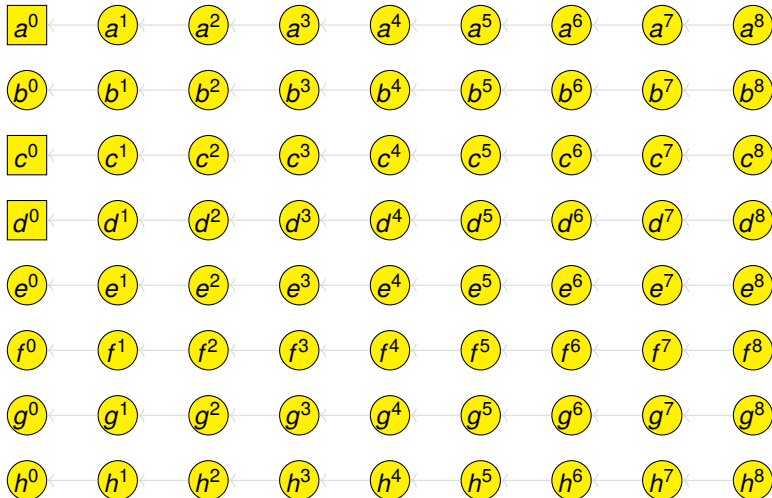

Parallel plans

Relaxed planning graphs

Introduction
Construction
Truth values

Relaxation heuristics

Summary

Relaxed planning graph: idle arcs

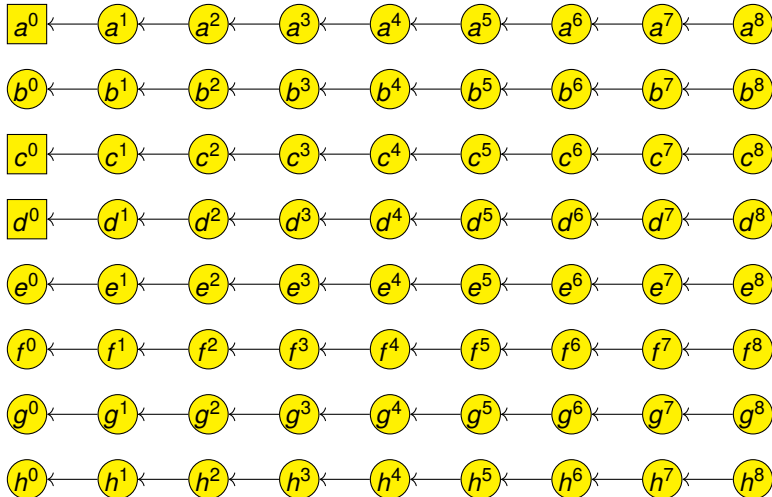

Parallel plans

Relaxed planning graphs

Introduction
Construction
Truth values

Relaxation heuristics

Summary



For each $i \in \{1, \dots, k\}$ and each operator $o^+ = \langle \chi, e^+ \rangle \in O^+$, $RPG_k(\Pi^+)$ contains a subgraph called an **operator subgraph** with the following parts:

- one **formula node** n_φ^i for each formula φ which is a subformula of χ or of some effect condition in e^+ :
 - If $\varphi = a$ for some atom a , n_φ^i is the proposition node a^{i-1} .
 - If $\varphi = \top$, n_φ^i is a new AND node without outgoing arcs.
 - If $\varphi = \perp$, n_φ^i is a new OR node without outgoing arcs.
 - If $\varphi = (\varphi' \wedge \varphi'')$, n_φ^i is a new AND node with outgoing arcs to $n_{\varphi'}^i$ and $n_{\varphi''}^i$.
 - If $\varphi = (\varphi' \vee \varphi'')$, n_φ^i is a new OR node with outgoing arcs to $n_{\varphi'}^i$ and $n_{\varphi''}^i$.

Parallel plans

Relaxed planning graphs

Introduction
Construction
Truth values

Relaxation heuristics

Summary



For each $i \in \{1, \dots, k\}$ and each operator $o^+ = \langle \chi, e^+ \rangle \in O^+$, $RPG_k(\Pi^+)$ contains a subgraph called an **operator subgraph** with the following parts:

- for each conditional effect $(\chi' \triangleright a)$ in e^+ , an **effect node** $o_{\chi'}^i$ (an AND node) with outgoing arcs to the precondition formula node n_{χ}^i and effect condition formula node $n_{\chi'}^i$, and incoming arc from proposition node a^i
 - unconditional effects a (effects which are not part of a conditional effect) are treated the same, except that there is no arc to an effect condition formula node
 - effects with identical condition (including groups of unconditional effects) share the same effect node
 - the effect node for unconditional effects is denoted by o^i

Parallel plans

Relaxed planning graphs

Introduction
Construction
Truth values

Relaxation heuristics

Summary

Relaxed planning graph: operator subgraphs



Operator subgraph for $o_1 = \langle b \vee (c \wedge d), b \wedge ((a \wedge b) \triangleright e) \rangle$
for layer $i = 1$.

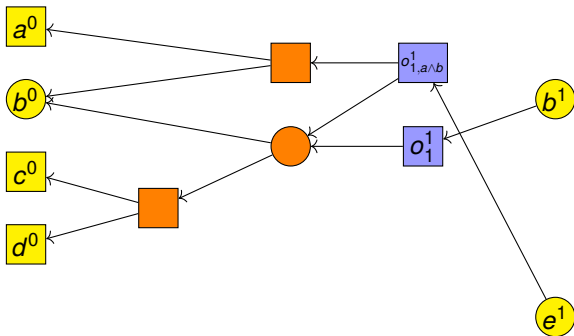

Parallel
plans

Relaxed
planning
graphs

Introduction
Construction
Truth values

Relaxation
heuristics

Summary



$RPG_k(\Pi^+)$ contains a subgraph called a **goal subgraph** with the following parts:

- one **formula node** n_φ^k for each formula φ which is a subformula of γ :
 - If $\varphi = a$ for some atom a , n_φ^k is the proposition node a^i .
 - If $\varphi = \top$, n_φ^k is a new AND node without outgoing arcs.
 - If $\varphi = \perp$, n_φ^k is a new OR node without outgoing arcs.
 - If $\varphi = (\varphi' \wedge \varphi'')$, n_φ^k is a new AND node with outgoing arcs to $n_{\varphi'}^k$ and $n_{\varphi''}^k$.
 - If $\varphi = (\varphi' \vee \varphi'')$, n_φ^k is a new OR node with outgoing arcs to $n_{\varphi'}^k$ and $n_{\varphi''}^k$.

The node n_γ^k is called the **goal node**.

Parallel plans

Relaxed planning graphs

Introduction
Construction
Truth values

Relaxation heuristics

Summary

Relaxed planning graph: goal subgraphs



Goal subgraph for $\gamma = e \wedge (g \wedge h)$ and depth $k = 2$:

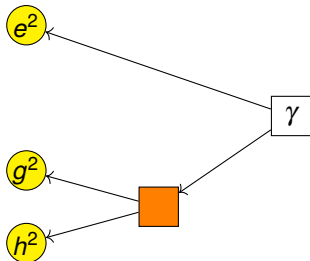

Parallel plans

Relaxed planning graphs

Introduction
Construction
Truth values

Relaxation heuristics

Summary

Relaxed planning graph: complete (depth 2)

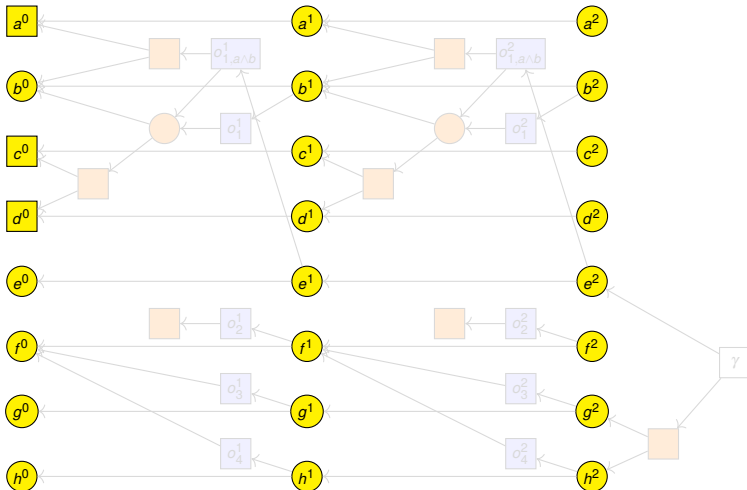

Parallel plans

Relaxed planning graphs

Introduction
Construction
Truth values

Relaxation heuristics

Summary

Relaxed planning graph: complete (depth 2)

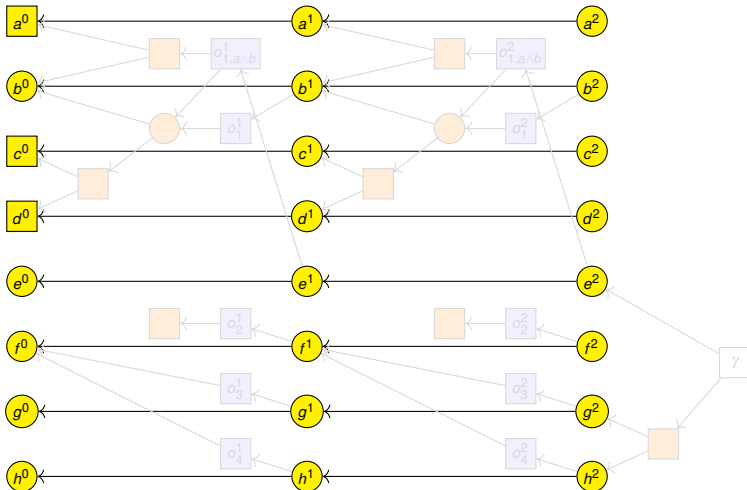

Parallel plans

Relaxed planning graphs

Introduction
Construction
Truth values

Relaxation heuristics

Summary

Relaxed planning graph: complete (depth 2)



$$o_1 = \langle b \vee (c \wedge d), b \wedge ((a \wedge b) \triangleright e) \rangle$$

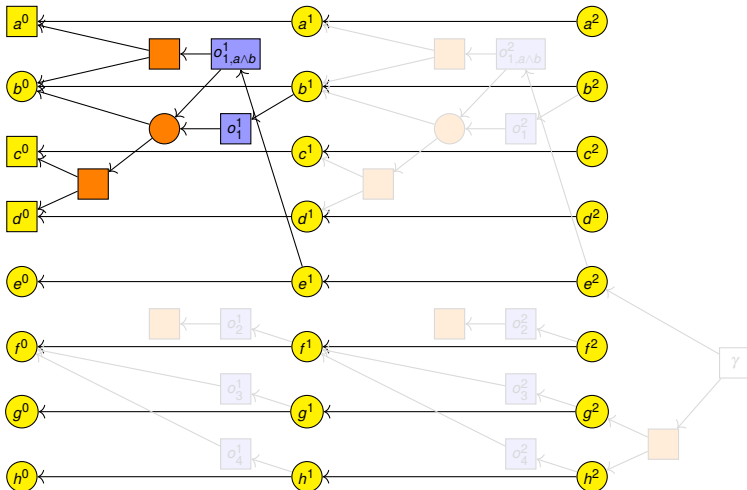

Parallel plans

Relaxed planning graphs

Introduction
Construction
Truth values

Relaxation heuristics

Summary

Relaxed planning graph: complete (depth 2)



$$o_1 = \langle b \vee (c \wedge d), b \wedge ((a \wedge b) \triangleright e) \rangle$$

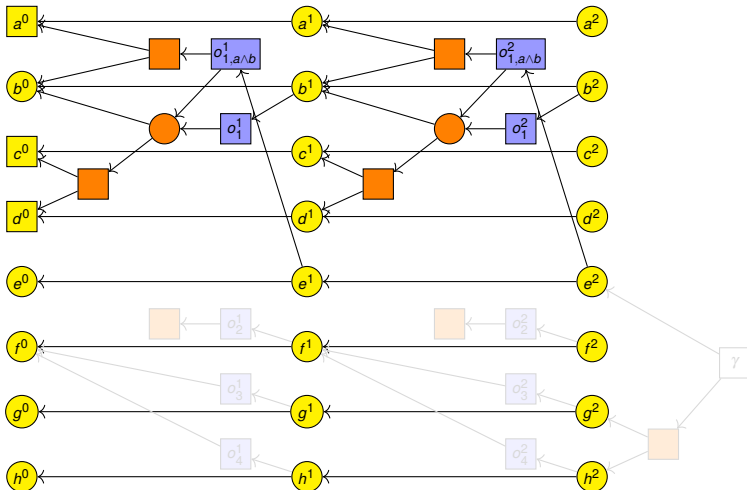

Parallel plans

Relaxed planning graphs

Introduction
Construction
Truth values

Relaxation heuristics

Summary

Relaxed planning graph: complete (depth 2)



$O_2 = \langle T, f \rangle$

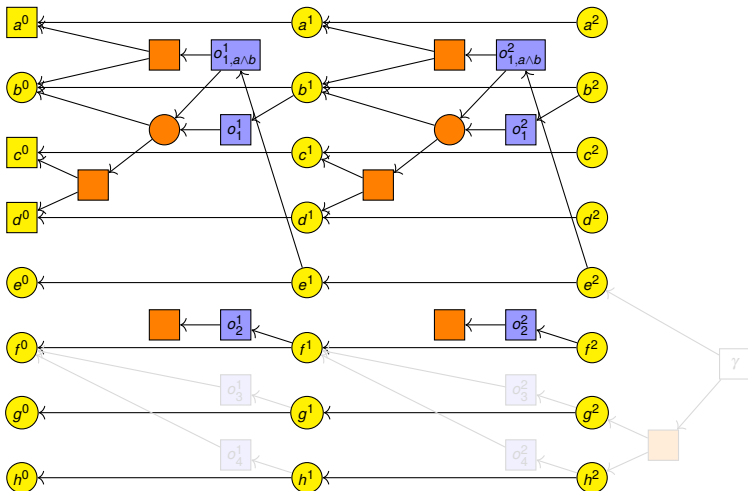

Parallel plans

Relaxed planning graphs

Introduction
Construction
Truth values

Relaxation heuristics

Summary

Relaxed planning graph: complete (depth 2)



$o_3 = \langle f, g \rangle$

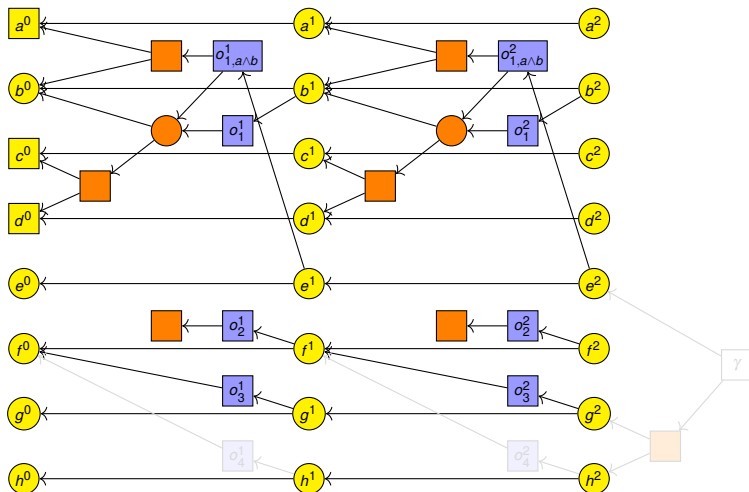

Parallel plans

Relaxed planning graphs

Introduction
Construction
Truth values

Relaxation heuristics

Summary

Relaxed planning graph: complete (depth 2)



$$o_4 = \langle f, h \rangle$$

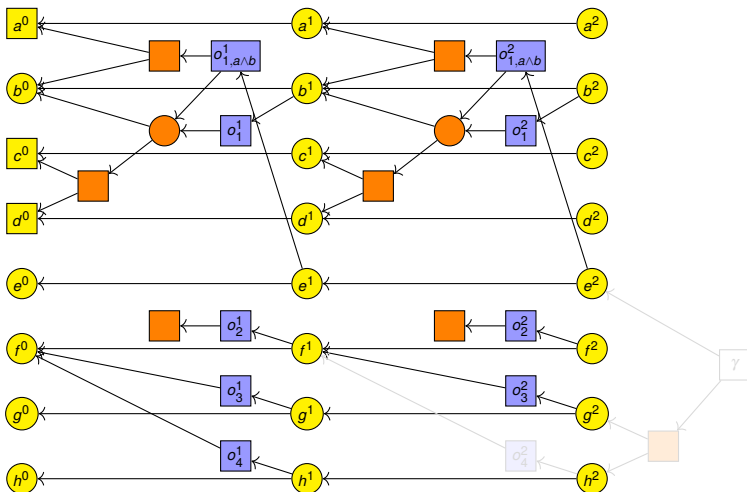

Parallel plans

Relaxed planning graphs

Introduction
Construction
Truth values

Relaxation heuristics

Summary

Relaxed planning graph: complete (depth 2)



$$o_4 = \langle f, h \rangle$$

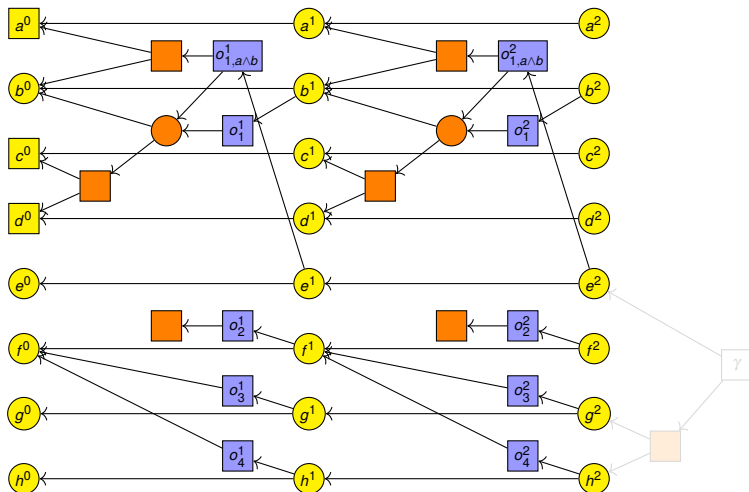

Parallel plans

Relaxed planning graphs

Introduction
Construction
Truth values

Relaxation heuristics

Summary

Relaxed planning graph: complete (depth 2)



$$\gamma = e \wedge (g \wedge h)$$

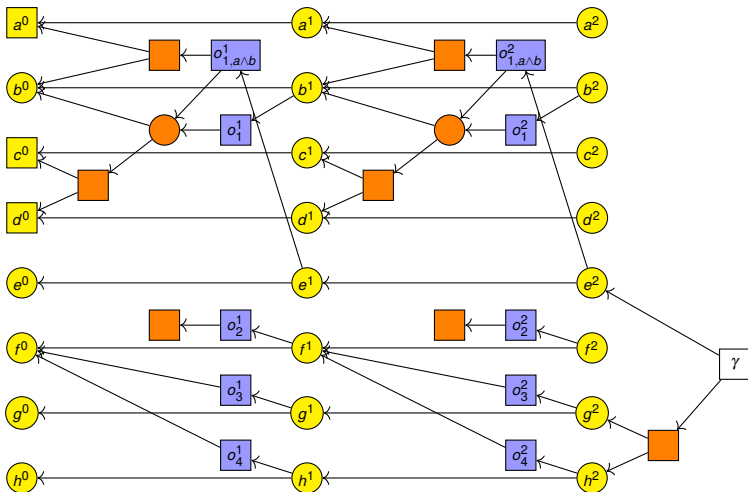

Parallel plans

Relaxed planning graphs

Introduction
Construction
Truth values

Relaxation heuristics

Summary

Relaxed planning graph: complete (depth 2)

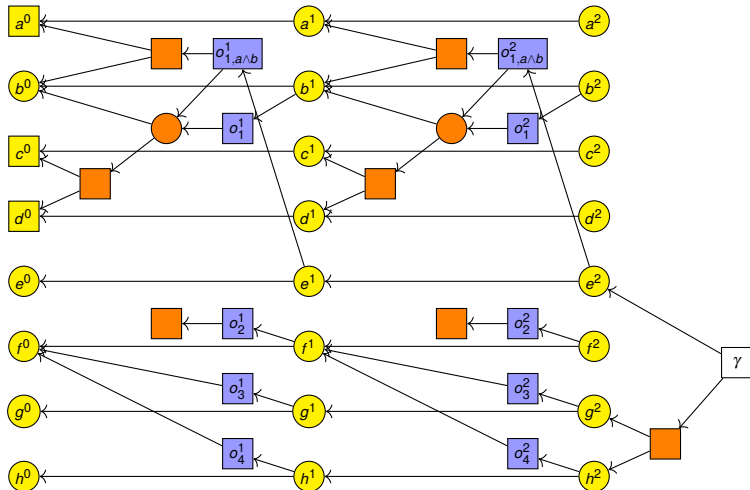

Parallel plans

Relaxed planning graphs

Introduction
Construction
Truth values

Relaxation heuristics

Summary



Theorem (relaxed planning graph truth values)

Let $\Pi^+ = \langle A, I, O^+, \gamma \rangle$ be a relaxed planning task.

Then the truth values of the nodes of its depth- k relaxed planning graph $RPG_k(\Pi^+)$ relate to the forward sets and forward plan steps of Π^+ as follows:

■ **Proposition nodes:**

For all $a \in A$ and $i \in \{0, \dots, k\}$, $val(a^i) = 1$ iff $a \in S_i^F$.

■ **(Unconditional) effect nodes:**

For all $o \in O^+$ and $i \in \{1, \dots, k\}$, $val(o^i) = 1$ iff $o \in \omega_i^F$.

■ **Goal nodes:**

$val(n_\gamma^k) = 1$ iff the parallel forward distance of Π^+ is at most k .

(We omit the straight-forward proof.)

Parallel plans

Relaxed planning graphs

Introduction
Construction
Truth values

Relaxation heuristics

Summary

Computing the node truth values

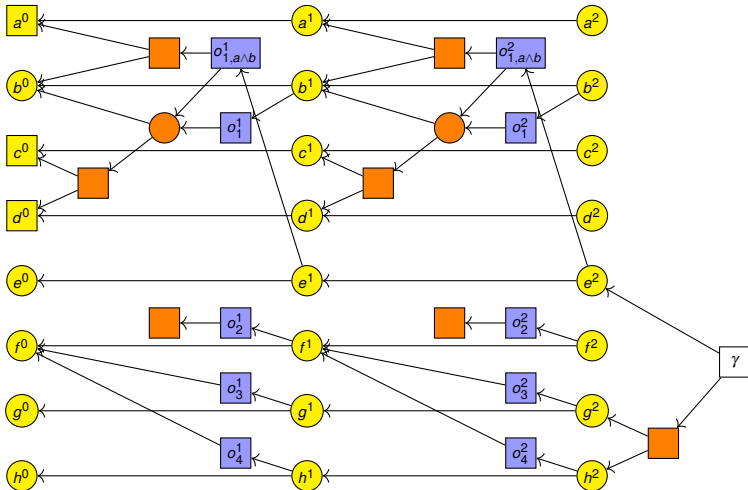

Parallel plans

Relaxed planning graphs

Introduction
Construction
Truth values

Relaxation heuristics

Summary

Computing the node truth values

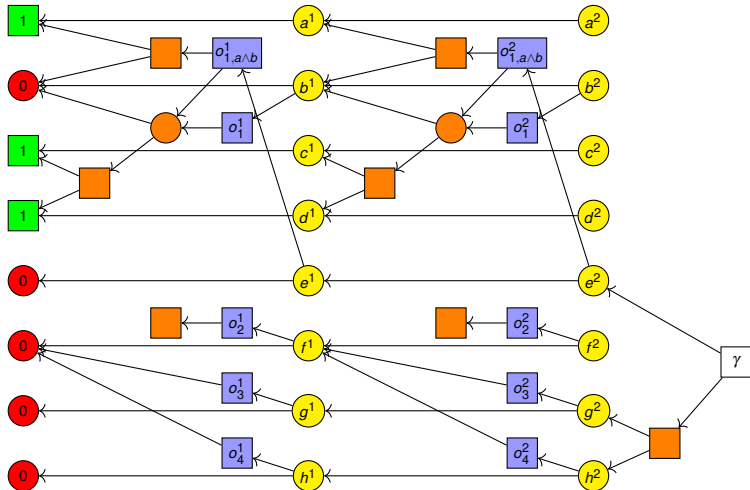

Parallel plans

Relaxed planning graphs

Introduction
Construction
Truth values

Relaxation heuristics

Summary

Computing the node truth values

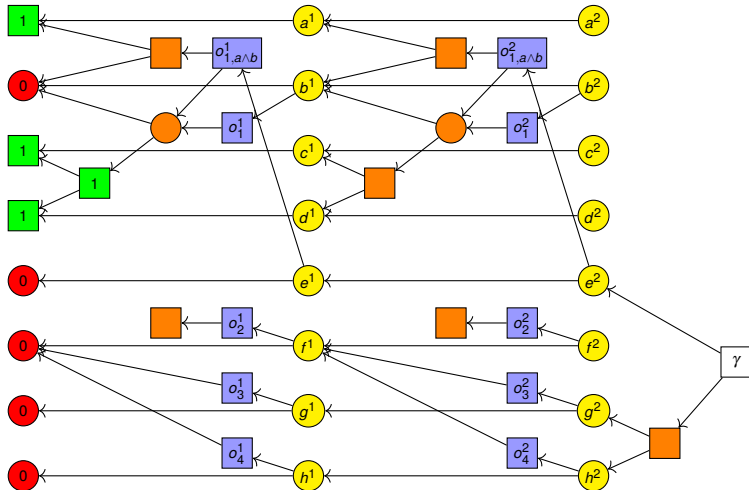

Parallel plans

Relaxed planning graphs

Introduction
Construction
Truth values

Relaxation heuristics

Summary

Computing the node truth values

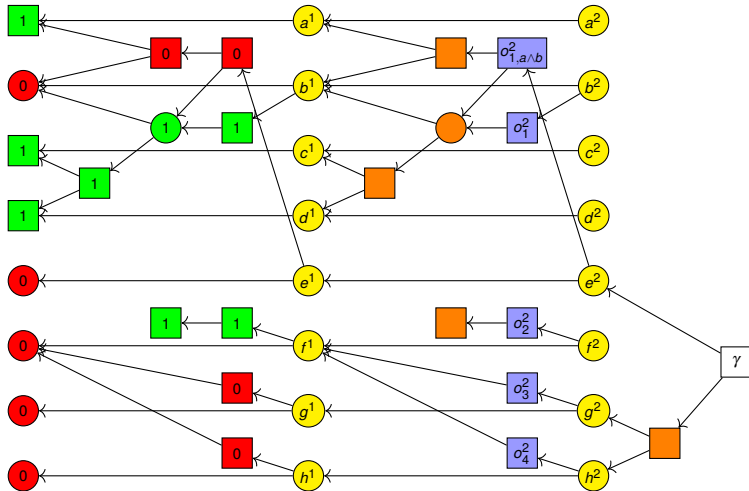

Parallel plans

Relaxed planning graphs

Introduction
Construction
Truth values

Relaxation heuristics

Summary

Computing the node truth values

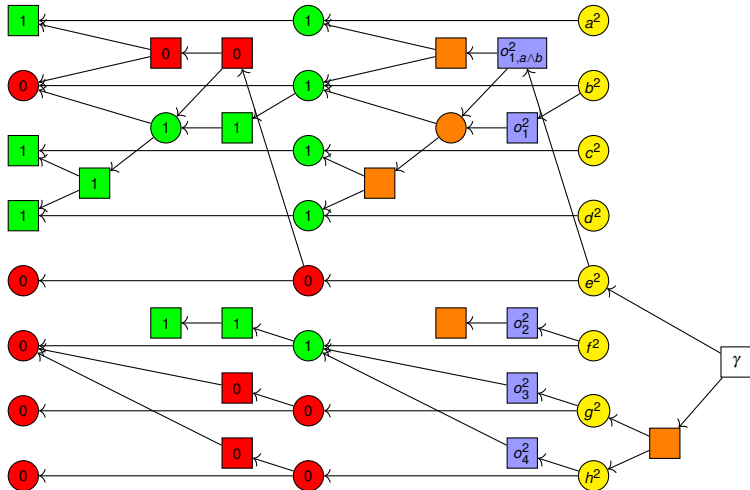

Parallel plans

Relaxed planning graphs

Introduction
Construction
Truth values

Relaxation heuristics

Summary

Computing the node truth values

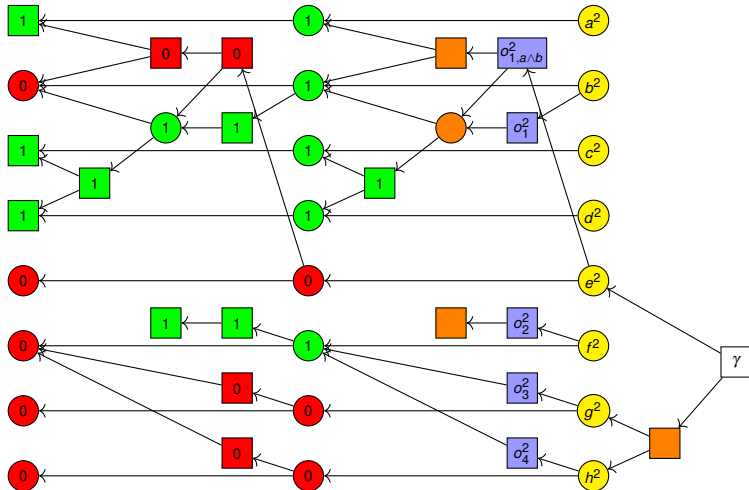

Parallel plans

Relaxed planning graphs

Introduction
Construction
Truth values

Relaxation heuristics

Summary

Computing the node truth values

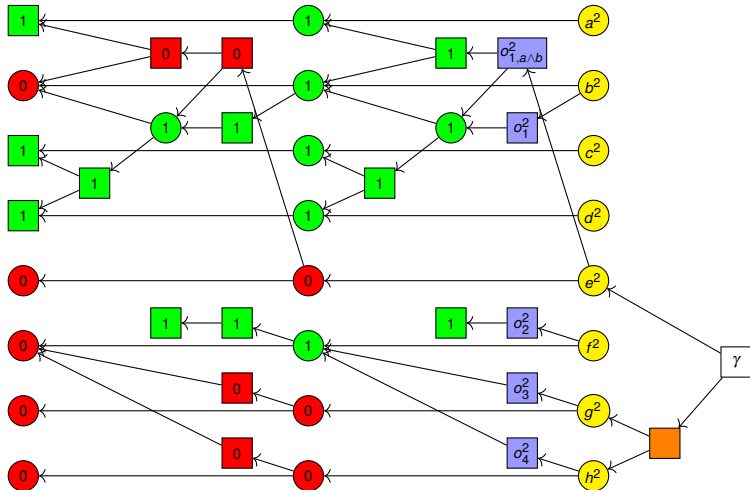

Parallel plans

Relaxed planning graphs

Introduction
Construction
Truth values

Relaxation heuristics

Summary

Computing the node truth values

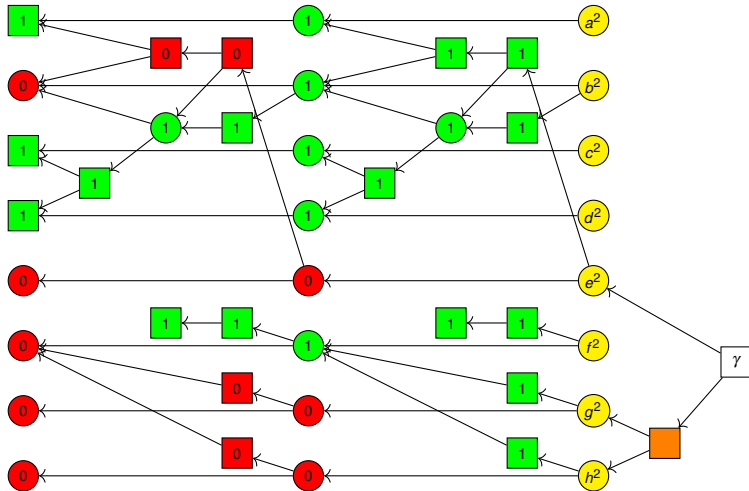

Parallel plans

Relaxed planning graphs

Introduction
Construction
Truth values

Relaxation heuristics

Summary

Computing the node truth values

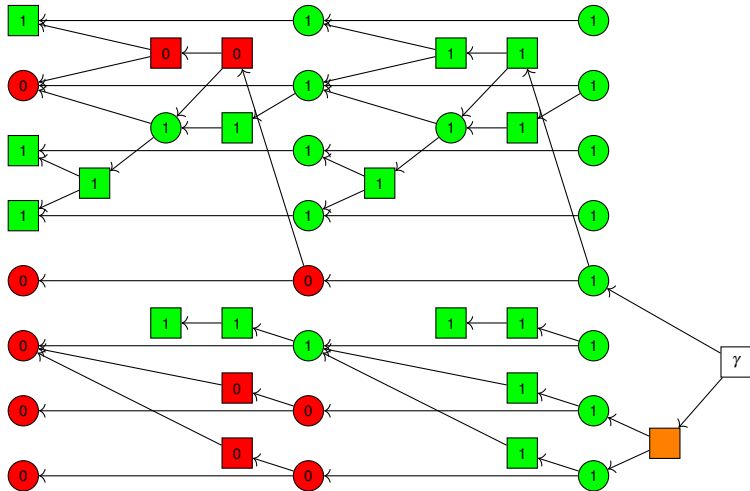

Parallel plans

Relaxed planning graphs

Introduction
Construction
Truth values

Relaxation heuristics

Summary

Computing the node truth values

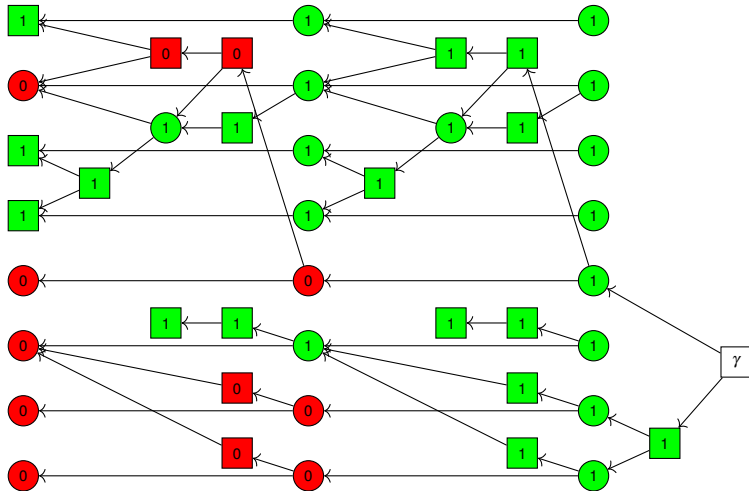

Parallel plans

Relaxed planning graphs

Introduction
Construction
Truth values

Relaxation heuristics

Summary

Computing the node truth values

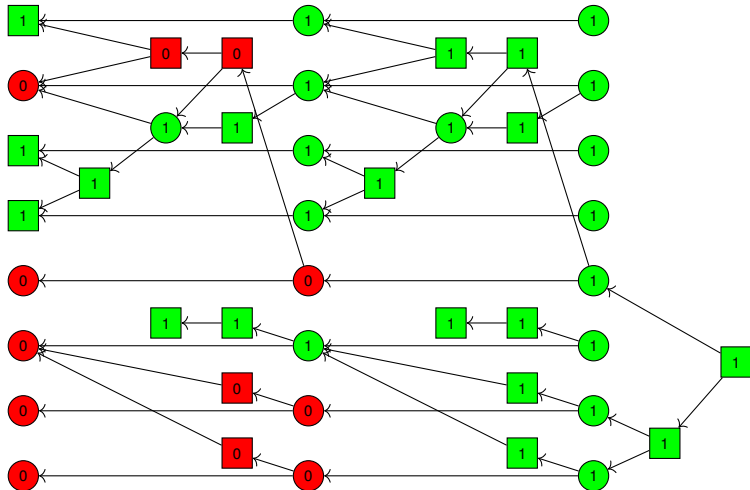

Parallel plans

Relaxed planning graphs

Introduction
Construction
Truth values

Relaxation heuristics

Summary



Remark: Relaxed planning graphs have historically been defined for STRIPS tasks only. In this case, we can simplify:

- **Only one effect node per operator:** STRIPS does not have conditional effects.
 - Because each operator has only one effect node, effect nodes are called **operator nodes** in relaxed planning graphs for STRIPS.
- **No goal nodes:** The test whether all goals are reached is done by the algorithm that evaluates the AND/OR dag.
- **No formula nodes:** Operator nodes are directly connected to their preconditions.

↪ Relaxed planning graphs for STRIPS are **layered** digraphs and only have **proposition and operator nodes**.

Parallel plans

Relaxed planning graphs

Introduction
Construction
Truth values

Relaxation heuristics

Summary



Relaxation heuristics

Parallel plans

Relaxed planning graphs

Relaxation heuristics

Generic template

h_{max}

h_{add}

h_{sa}

Incremental computation

h_{FF}

Comparison & practice

Summary

Computing parallel forward distances from RPGs



So far, relaxed planning graphs offer us a way to compute parallel forward distances:

Parallel forward distances from relaxed planning graphs

def *parallel-forward-distance*(Π^+):

Let A be the set of state variables of Π^+ .

for $k \in \{0, 1, 2, \dots\}$:

$rpg := RPG_k(\Pi^+)$

Evaluate truth values for rpg .

if goal node of rpg has value 1:

return k

else if $k = |A|$:

return ∞

Parallel plans

Relaxed planning graphs

Relaxation heuristics

Generic template

h_{max}

h_{add}

h_{sa}

Incremental computation

h_{FF}

Comparison & practice

Summary



- The relaxed planning graph for depth $k \geq 1$ can be built **incrementally** from the one for depth $k - 1$:
 - Add new layer k .
 - Move goal subgraph from layer $k - 1$ to layer k .
- Similarly, all truth values up to layer $k - 1$ can be reused.
- Thus, overall computation with maximal depth m requires time $O(\|RPG_m(\Pi^+)\|) = O((m + 1) \cdot \|\Pi^+\|)$.
- This is not a very efficient way of computing parallel forward distances (and wouldn't be used in practice).
- However, it allows computing **additional information** for the relaxed planning graph nodes along the way, which can be used for heuristic estimates.

Parallel plans

Relaxed planning graphs

Relaxation heuristics

Generic template

h_{max}

h_{add}

h_{sa}

Incremental computation

h_{FF}

Comparison & practice

Summary



Computing heuristics from relaxed planning graphs

```
def generic-rpg-heuristic( $\langle A, I, O, \gamma \rangle, s$ ):  
     $\Pi^+ := \langle A, s, O^+, \gamma \rangle$   
    for  $k \in \{0, 1, 2, \dots\}$ :  
         $rpg := RPG_k(\Pi^+)$   
        Evaluate truth values for  $rpg$ .  
        if goal node of  $rpg$  has value 1:  
            Annotate true nodes of  $rpg$ .  
            if termination criterion is true:  
                return heuristic value from annotations  
        else if  $k = |A|$ :  
            return  $\infty$ 
```

\rightsquigarrow **generic template** for heuristic functions

\rightsquigarrow to get **concrete heuristic**: fill in **highlighted parts**

Parallel
plans

Relaxed
planning
graphs

Relaxation
heuristics

Generic template

h_{max}

h_{add}

h_{sa}

Incremental
computation

h_{FF}

Comparison &
practice

Summary



Many planning heuristics fit the generic template:

- **additive heuristic** h_{add} (Bonet, Loerincs & Geffner, 1997)
- **max heuristic** h_{max} (Bonet & Geffner, 1999)
- **FF heuristic** h_{FF} (Hoffmann & Nebel, 2001)
- **cost-sharing heuristic** h_{CS} (Mirkis & Domshlak, 2007)
 - not covered in this course
- **set-additive heuristic** h_{sa} (Keyder & Geffner, 2008)

Remarks:

- For all these heuristics, equivalent definitions that don't refer to relaxed planning graphs are possible.
- Historically, such equivalent definitions have mostly been used for h_{max} , h_{add} and h_{sa} .
- For those heuristics, the most efficient implementations do not use relaxed planning graphs explicitly.

Parallel
plans

Relaxed
planning
graphs

Relaxation
heuristics

Generic template

h_{max}

h_{add}

h_{sa}

Incremental
computation

h_{FF}

Comparison &
practice

Summary



- The simplest relaxed planning graph heuristics are **forward cost heuristics**.
- Examples: h_{\max} , h_{add}
- Here, node annotations are **cost values** (natural numbers).
- The cost of a node estimates how expensive (in terms of required operators) it is to make this node true.

Parallel plans

Relaxed planning graphs

Relaxation heuristics

Generic template

h_{\max}

h_{add}

h_{sa}

Incremental computation

h_{FF}

Comparison & practice

Summary



Forward cost heuristics

Computing annotations:

- Propagate cost values bottom-up using a **combination rules** for OR nodes and for AND nodes.
- At **effect nodes**, **add 1** after applying combination rule.

Termination criterion:

- **stability**: terminate if cost for proposition node a^k equals cost for a^{k-1} for all true propositions a in layer k (and true propositions in layers k and $k - 1$ are the same)

Heuristic value:

- The heuristic value is the cost of the goal node.
- Different forward cost heuristics only differ in their choice of combination rules.

Parallel plans

Relaxed planning graphs

Relaxation heuristics

Generic template

h_{max}

h_{add}

h_{sa}

Incremental computation

h_{FF}

Comparison & practice

Summary

The max heuristic h_{\max} (again)



Forward cost heuristics: max heuristic h_{\max}

Combination rule for AND nodes:

- $cost(u) = \max(\{cost(v_1), \dots, cost(v_k)\})$
(with $\max(\emptyset) := 0$)

Combination rule for OR nodes:

- $cost(u) = \min(\{cost(v_1), \dots, cost(v_k)\})$

In both cases, $\{v_1, \dots, v_k\}$ is the set of true successors of u .

Intuition:

- **AND rule:** If we have to achieve several conditions, estimate this by the **most expensive** cost.
- **OR rule:** If we have a choice how to achieve a condition, pick the **cheapest** possibility.

Parallel plans

Relaxed planning graphs

Relaxation heuristics

Generic template

h_{\max}

h_{add}

h_{sa}

Incremental computation

h_{FF}

Comparison & practice

Summary

Running example: h_{\max}

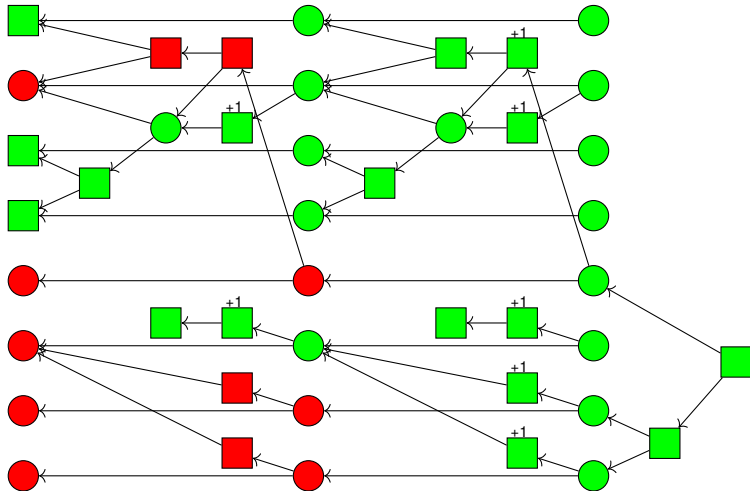

Parallel plans

Relaxed planning graphs

Relaxation heuristics

Generic template

h_{\max}

h_{add}

h_{sa}

Incremental computation

h_{FF}

Comparison & practice

Summary

Running example: h_{\max}

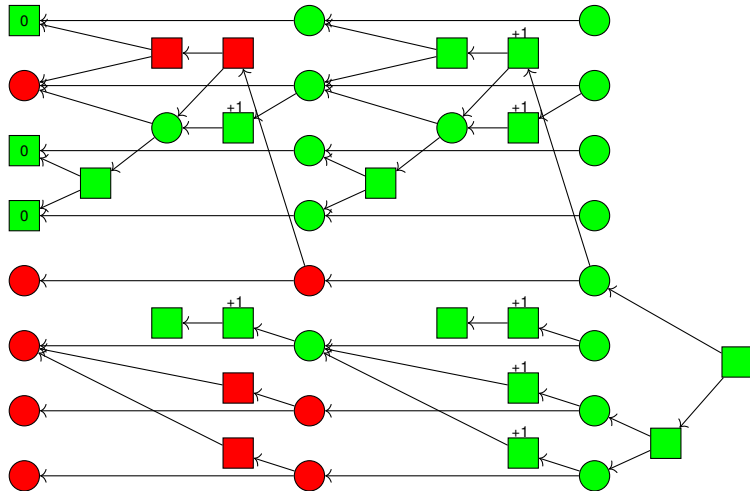

Parallel plans

Relaxed planning graphs

Relaxation heuristics

Generic template

h_{\max}

h_{add}

h_{sa}

Incremental computation

h_{FF}

Comparison & practice

Summary

Running example: h_{\max}

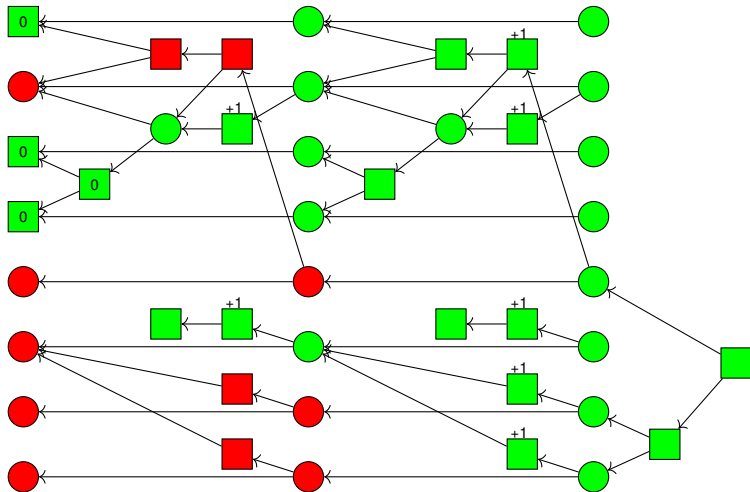

Parallel plans

Relaxed planning graphs

Relaxation heuristics

Generic template

h_{\max}

h_{add}

h_{sa}

Incremental computation

h_{FF}

Comparison & practice

Summary

Running example: h_{\max}

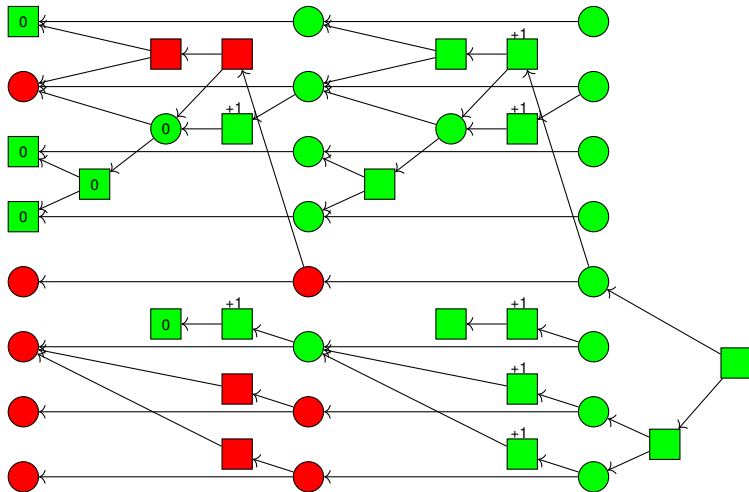

Parallel plans

Relaxed planning graphs

Relaxation heuristics

Generic template

h_{\max}

h_{add}

h_{sa}

Incremental computation

h_{FF}

Comparison & practice

Summary

Running example: h_{\max}

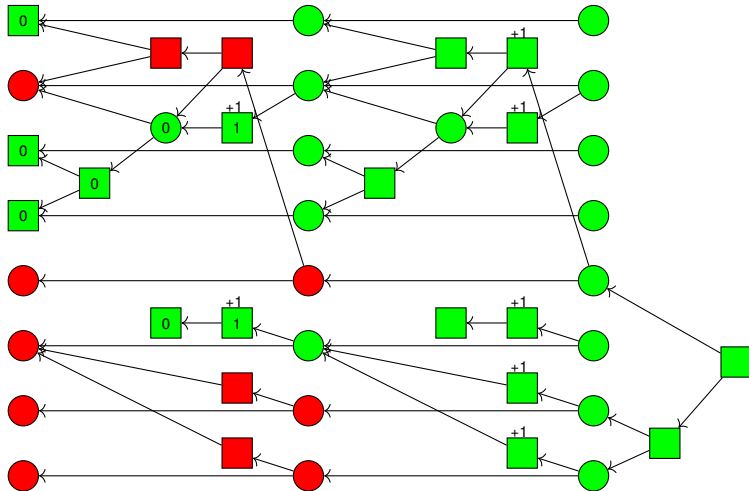

Parallel plans

Relaxed planning graphs

Relaxation heuristics

Generic template

h_{\max}

h_{add}

h_{sa}

Incremental computation

h_{FF}

Comparison & practice

Summary

Running example: h_{\max}

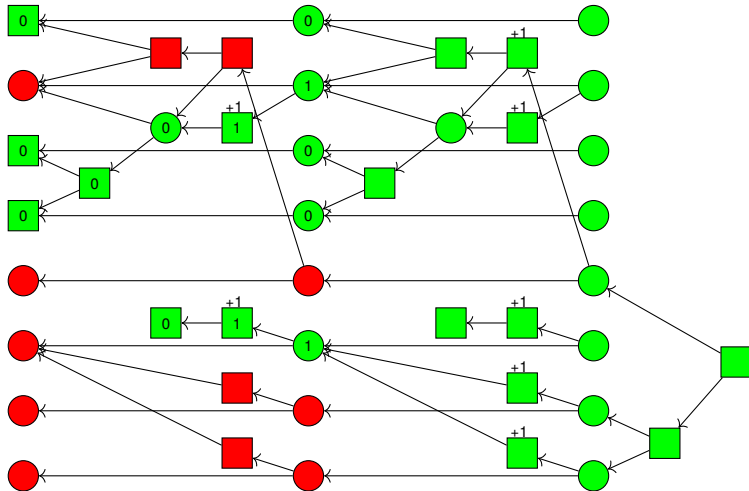

Parallel plans

Relaxed planning graphs

Relaxation heuristics

Generic template

h_{\max}

h_{add}

h_{sa}

Incremental computation

h_{FF}

Comparison & practice

Summary

Running example: h_{\max}

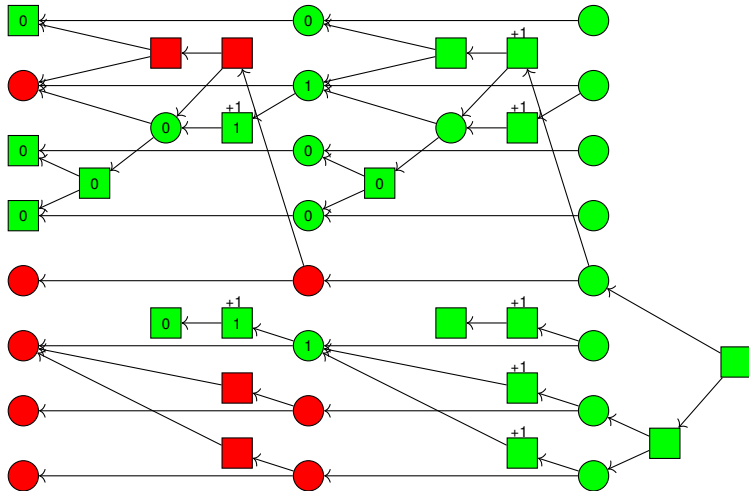

Parallel plans

Relaxed planning graphs

Relaxation heuristics

Generic template

h_{\max}

h_{add}

h_{sa}

Incremental computation

h_{FF}

Comparison & practice

Summary

Running example: h_{\max}

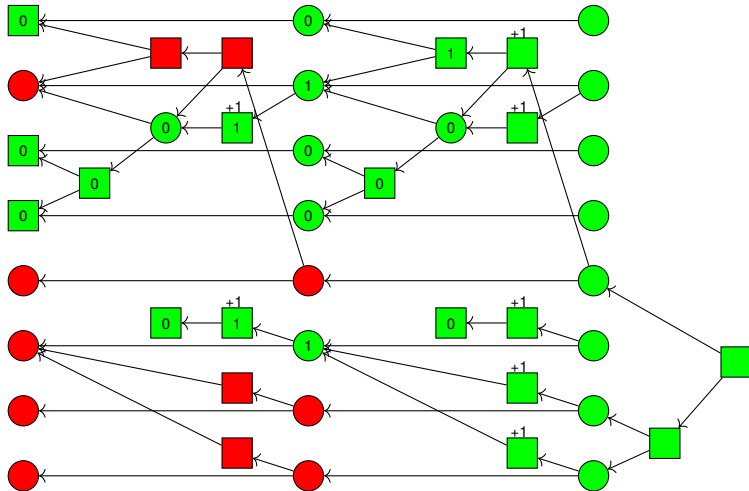

Parallel plans

Relaxed planning graphs

Relaxation heuristics

Generic template

h_{\max}

h_{add}

h_{sa}

Incremental computation

h_{FF}

Comparison & practice

Summary

Running example: h_{\max}

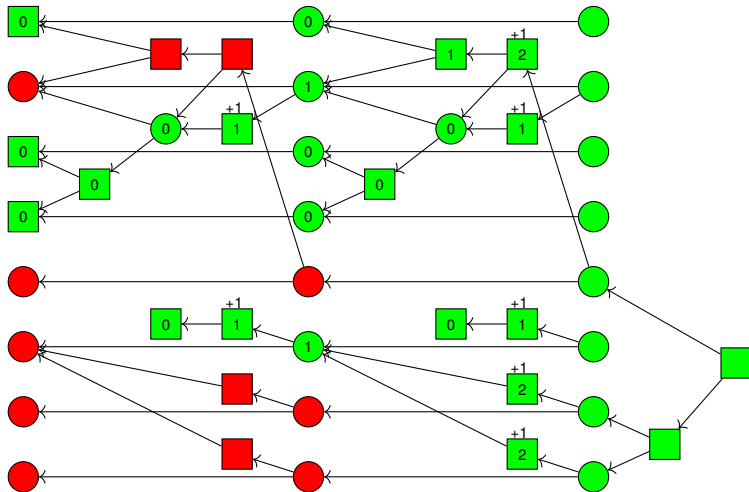

Parallel plans

Relaxed planning graphs

Relaxation heuristics

Generic template

h_{\max}

h_{add}

h_{sa}

Incremental computation

h_{FF}

Comparison & practice

Summary

Running example: h_{\max}

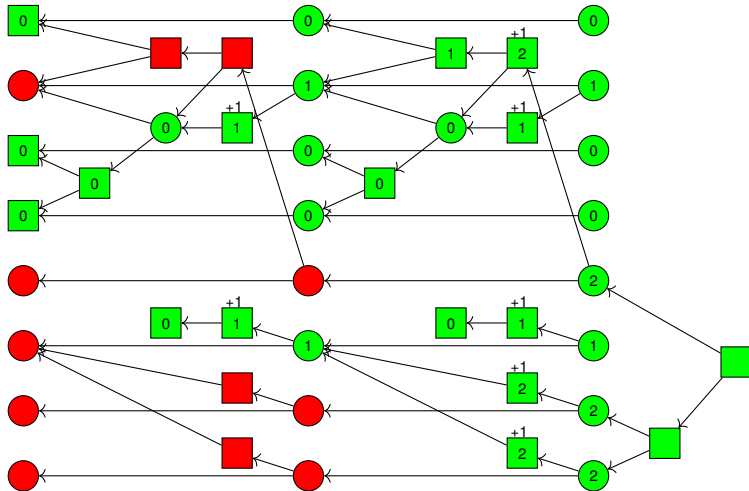

Parallel plans

Relaxed planning graphs

Relaxation heuristics

Generic template

h_{\max}

h_{add}

h_{sa}

Incremental computation

h_{FF}

Comparison & practice

Summary

Running example: h_{\max}

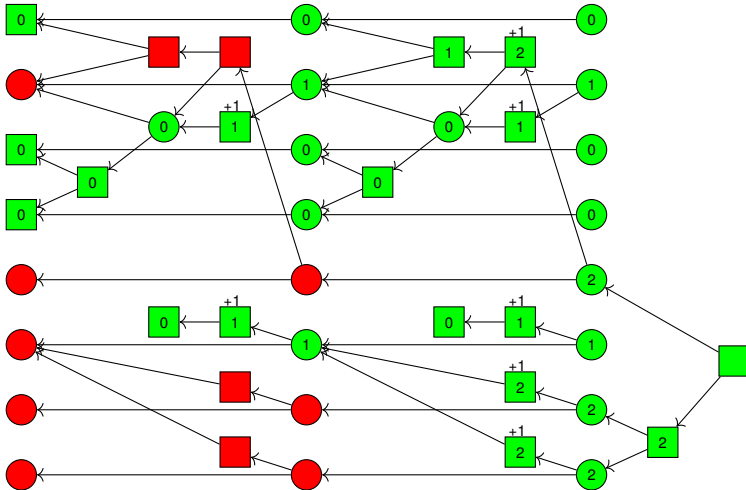

Parallel plans

Relaxed planning graphs

Relaxation heuristics

Generic template

h_{\max}

h_{add}

h_{sa}

Incremental computation

h_{FF}

Comparison & practice

Summary

Running example: h_{\max}

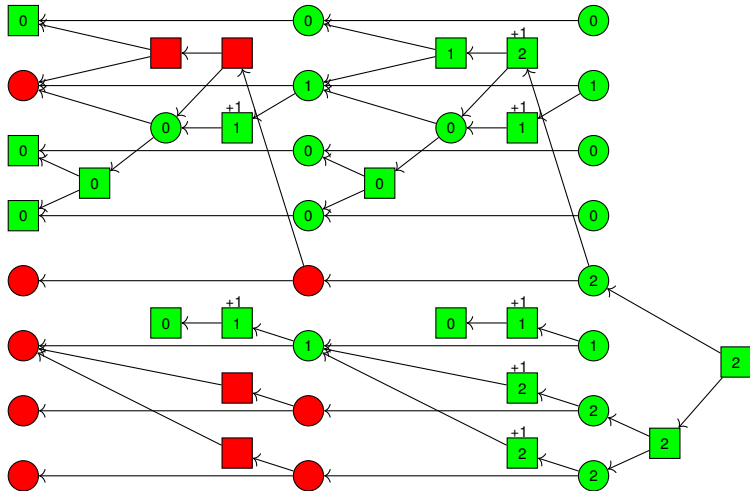

Parallel plans

Relaxed planning graphs

Relaxation heuristics

Generic template

h_{\max}

h_{add}

h_{sa}

Incremental computation

h_{FF}

Comparison & practice

Summary



- The definition of h_{\max} as a forward cost heuristic is equivalent to our earlier definition in this chapter.
- Unlike the earlier definition, it generalizes to an extension where every operator has an associated non-negative **cost** (rather than all operators having cost 1).
- In the case without costs (and only then), it is easy to prove that the goal node has the same cost in all graphs $RPG_k(\Pi^+)$ where it is true. (Namely, the cost is equal to the lowest value of k for which the goal node is true.)
- We can thus terminate the computation as soon as the goal becomes true, without waiting for stability.
- The same is **not true** for other forward-propagating heuristics (h_{add} , h_{CS} , h_{sa}).

Parallel plans

Relaxed planning graphs

Relaxation heuristics

Generic template

h_{\max}

h_{add}

h_{sa}

Incremental computation

h_{FF}

Comparison & practice

Summary



Forward cost heuristics: additive heuristic h_{add}

Combination rule for AND nodes:

- $cost(u) = cost(v_1) + \dots + cost(v_k)$
(with $\sum(\emptyset) := 0$)

Combination rule for OR nodes:

- $cost(u) = \min(\{cost(v_1), \dots, cost(v_k)\})$

In both cases, $\{v_1, \dots, v_k\}$ is the set of true successors of u .

Intuition:

- **AND rule:** If we have to achieve several conditions, estimate this by the cost of achieving **each in isolation**.
- **OR rule:** If we have a choice how to achieve a condition, pick the **cheapest** possibility.

Parallel plans

Relaxed planning graphs

Relaxation heuristics

Generic template

h_{max}

h_{add}

h_{ra}

Incremental computation

h_{FF}

Comparison & practice

Summary

Running example: h_{add}

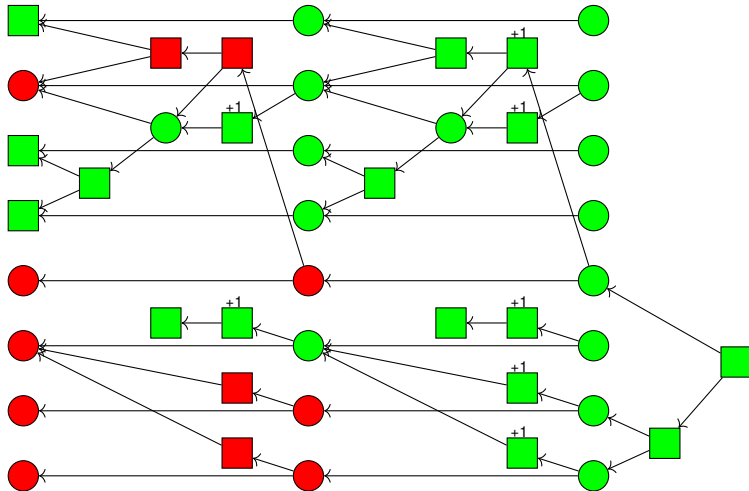

Parallel plans

Relaxed planning graphs

Relaxation heuristics

Generic template

h_{max}

h_{add}

h_{sa}

Incremental computation

h_{FF}

Comparison & practice

Summary

Running example: h_{add}

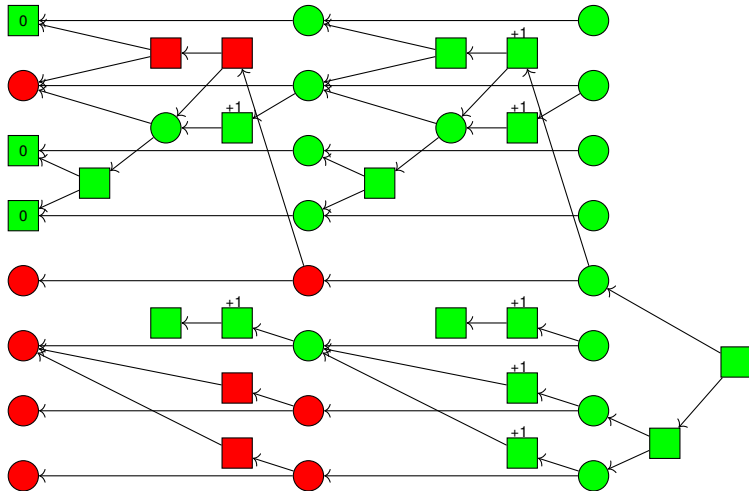

Parallel plans

Relaxed planning graphs

Relaxation heuristics

Generic template

h_{max}

h_{add}

h_{sa}

Incremental computation

h_{FF}

Comparison & practice

Summary

Running example: h_{add}

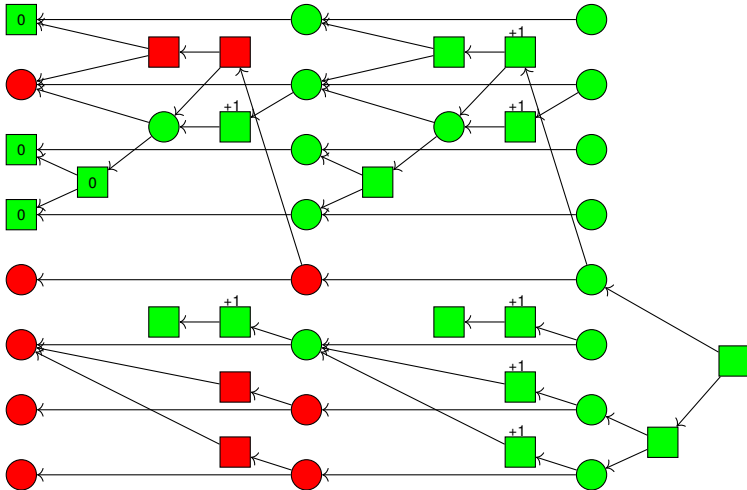

Parallel plans

Relaxed planning graphs

Relaxation heuristics

Generic template

h_{max}

h_{add}

h_{sa}

Incremental computation

h_{FF}

Comparison & practice

Summary

Running example: h_{add}

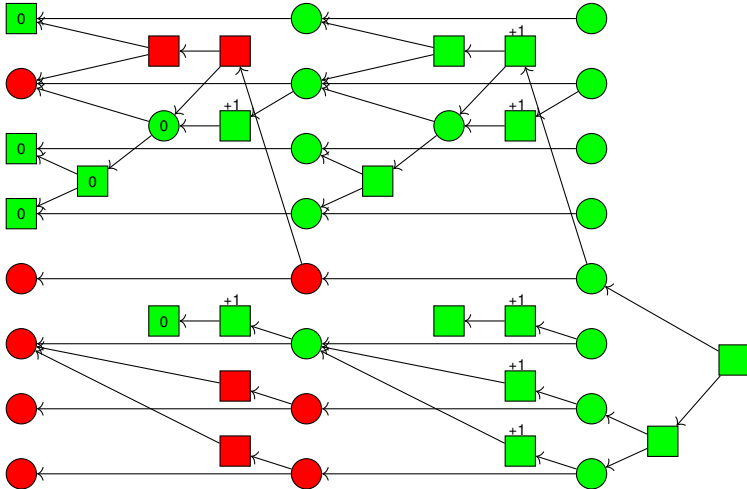

Parallel plans

Relaxed planning graphs

Relaxation heuristics

Generic template

h_{max}

h_{add}

h_{sa}

Incremental computation

h_{FF}

Comparison & practice

Summary

Running example: h_{add}

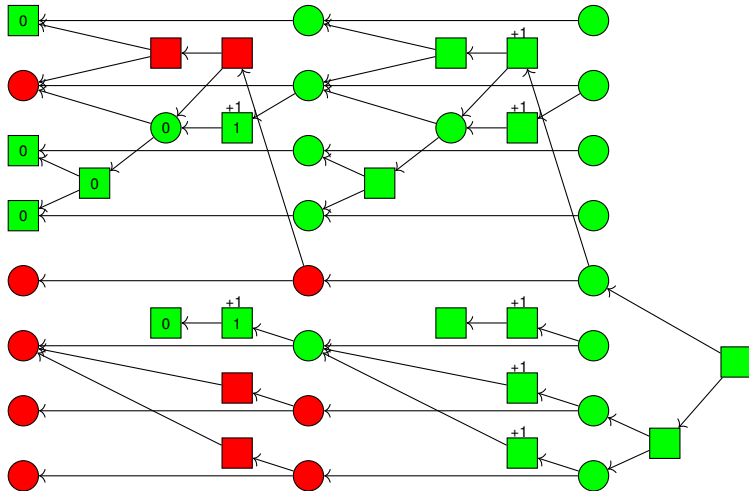

Parallel plans

Relaxed planning graphs

Relaxation heuristics

Generic template

h_{max}

h_{add}

h_{sa}

Incremental computation

h_{FF}

Comparison & practice

Summary

Running example: h_{add}

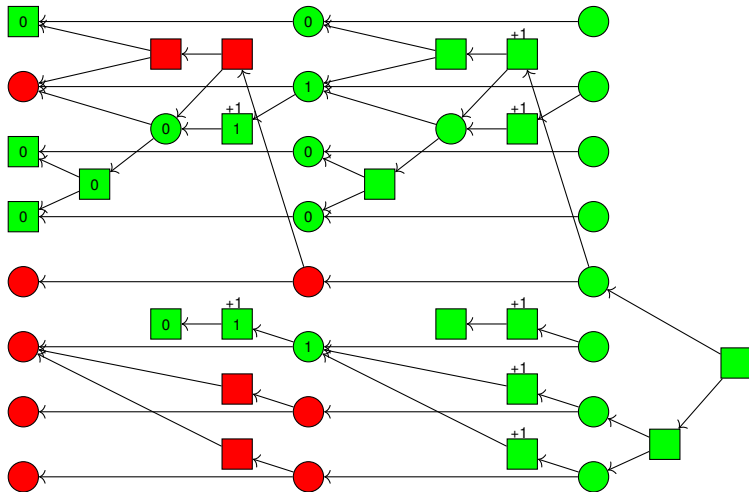

Parallel plans

Relaxed planning graphs

Relaxation heuristics

Generic template

h_{max}

h_{add}

h_{sa}

Incremental computation

h_{FF}

Comparison & practice

Summary

Running example: h_{add}

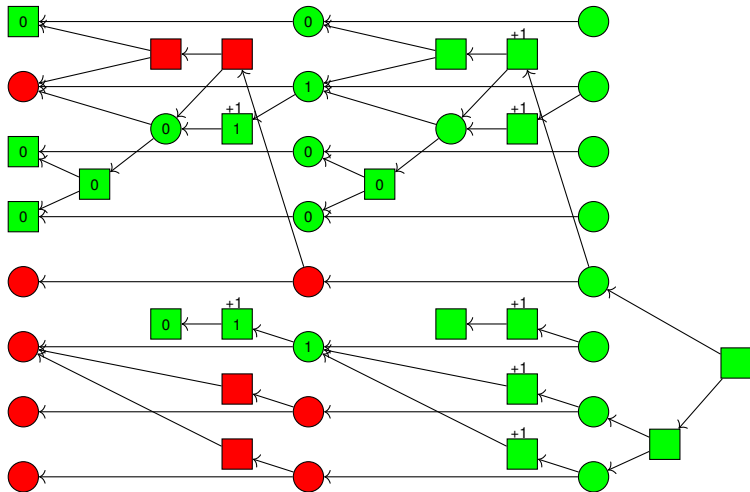

Parallel plans

Relaxed planning graphs

Relaxation heuristics

Generic template

h_{max}

h_{add}

h_{sa}

Incremental computation

h_{FF}

Comparison & practice

Summary

Running example: h_{add}

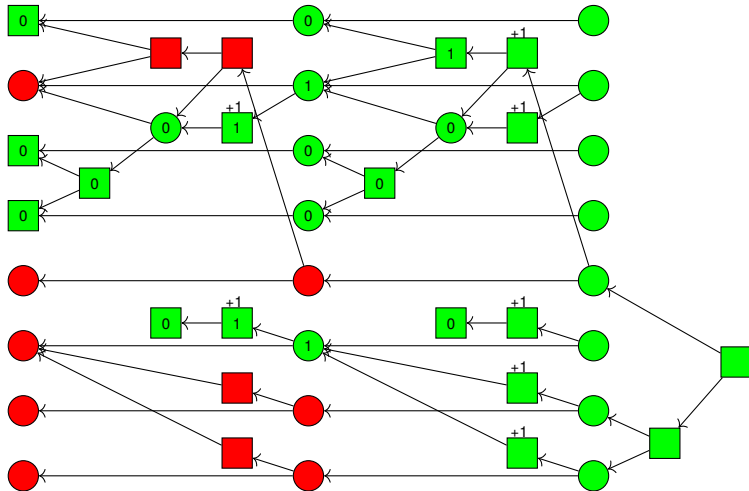

Parallel plans

Relaxed planning graphs

Relaxation heuristics

Generic template

h_{max}

h_{add}

h_{sa}

Incremental computation

h_{FF}

Comparison & practice

Summary

Running example: h_{add}

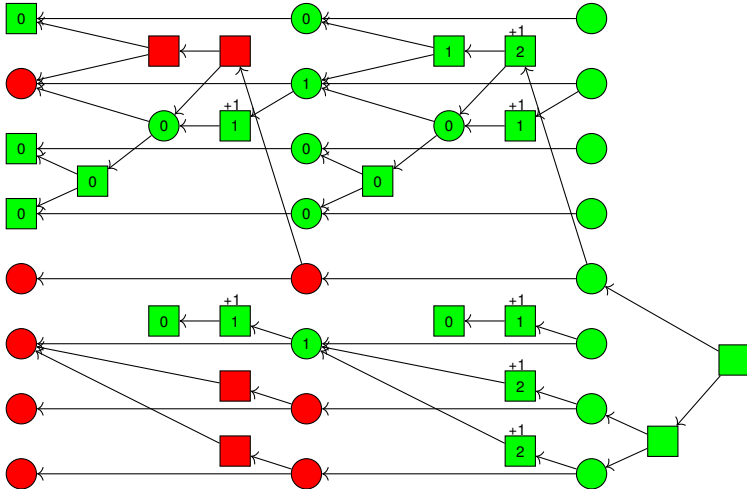

Parallel plans

Relaxed planning graphs

Relaxation heuristics

Generic template

h_{max}

h_{add}

h_{sa}

Incremental computation

h_{FF}

Comparison & practice

Summary

Running example: h_{add}

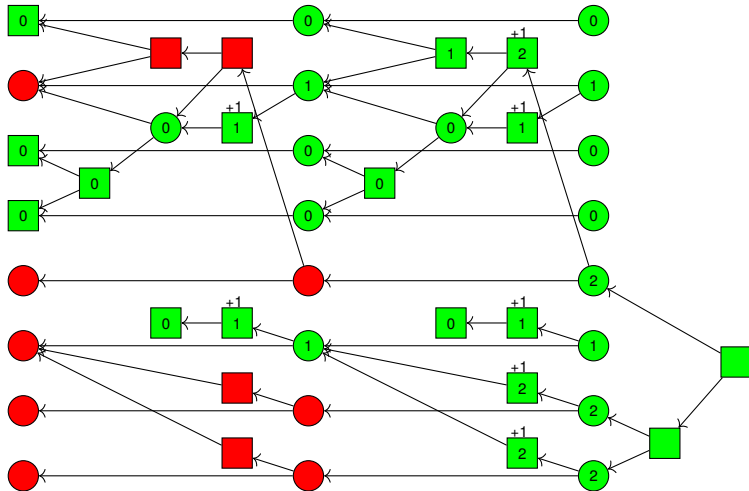

Parallel plans

Relaxed planning graphs

Relaxation heuristics

Generic template

h_{max}

h_{add}

h_{sa}

Incremental computation

h_{FF}

Comparison & practice

Summary

Running example: h_{add}

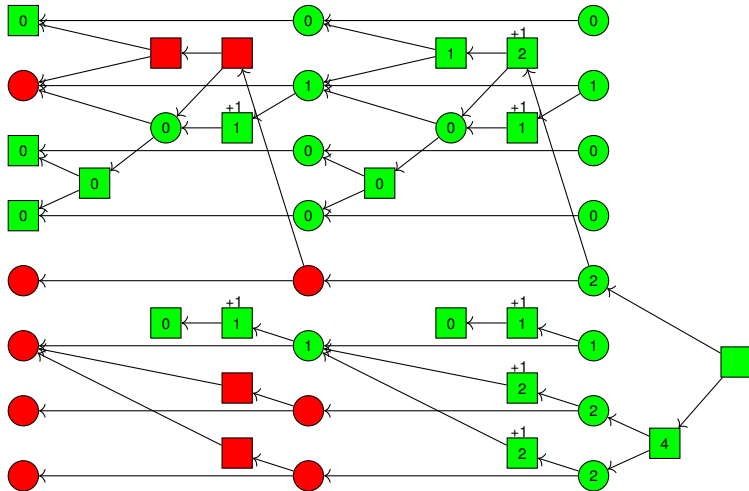

Parallel plans

Relaxed planning graphs

Relaxation heuristics

Generic template

h_{max}

h_{add}

h_{sa}

Incremental computation

h_{FF}

Comparison & practice

Summary

Running example: h_{add}

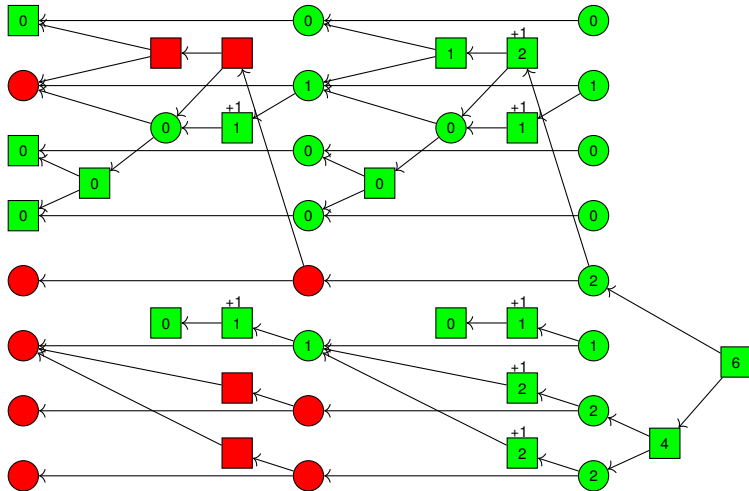

Parallel plans

Relaxed planning graphs

Relaxation heuristics

Generic template

h_{max}

h_{add}

h_{sa}

Incremental computation

h_{FF}

Comparison & practice

Summary



- It is important to test for stability in computing h_{add} !
(The reason for this is that, unlike h_{max} , cost values of true propositions can **decrease** from layer to layer.)
- Stability is achieved after layer $|A|$ in the worst case.
- h_{add} is **safe** and **goal-aware**.
- Unlike h_{max} , h_{add} is a **very informative** heuristic in many planning domains.
- The price for this is that it is **not admissible** (and hence also **not consistent**), so not suitable for optimal planning.
- In fact, it **almost always** overestimates the h^+ value because it does not take **positive interactions** into account.

Parallel plans

Relaxed planning graphs

Relaxation heuristics

Generic template

h_{max}

h_{add}

h_{sa}

Incremental computation

h_{FF}

Comparison & practice

Summary



- We now discuss a refinement of the additive heuristic called the **set-additive heuristic** h_{sa} .
- The set-additive heuristic addresses the problem that h_{add} does not take positive interactions into account.
- Like h_{max} and h_{add} , h_{sa} is calculated through **forward propagation** of node annotations.
- However, the node annotations are not cost values, but **sets of operators** (kind of).
- The idea is that by taking **set unions** instead of **adding costs**, operators needed only once are **counted only once**.

Disclaimer: There are some quite subtle differences between the h_{sa} heuristic as we describe it here and the “real” heuristic of Keyder & Geffner. We do not want to discuss this in detail, but please note that such differences exist.

Parallel plans

Relaxed planning graphs

Relaxation heuristics

Generic template

h_{max}

h_{add}

h_{sa}

Incremental computation

h_{FF}

Comparison & practice

Summary



- The original h_{sa} heuristic as described in the literature is defined for STRIPS tasks and propagates **sets of operators**.
- This is fine because in relaxed STRIPS tasks, each operator **need only be applied once**.
- The same is **not true in general**: in our running example, operator o_1 must be applied twice in the relaxed plan.
- In general, it only makes sense to apply an operator again in a relaxed planning task if a **previously unsatisfied effect condition** has been made true.
- For this reason, we keep track of **operator/effect condition pairs** rather than just plain operators.

Parallel plans

Relaxed planning graphs

Relaxation heuristics

Generic template

h_{max}

h_{add}

h_{sa}

Incremental computation

h_{FF}

Comparison & practice

Summary



The set-additive heuristic h_{sa}

Computing annotations:

- Annotations are **sets of operator/effect condition pairs**, computed bottom-up.

Combination rule for AND nodes:

- $ann(u) = ann(v_1) \cup \dots \cup ann(v_k)$ (with $\cup(\emptyset) := \emptyset$)

Combination rule for OR nodes:

- $ann(u) = ann(v_i)$ for some v_i minimizing $|ann(v_i)|$
In case of several minimizers, use any tie-breaking rule.

In both cases, $\{v_1, \dots, v_k\}$ is the set of true successors of u . At **effect nodes**, **add the corresponding operator/effect condition pair** to the set after applying combination rule.

...

Parallel plans

Relaxed planning graphs

Relaxation heuristics

Generic template

h_{max}

h_{add}

h_{sa}

Incremental computation

h_{FF}

Comparison & practice

Summary

Set-additive heuristic: fitting the template (ctd.)



The set-additive heuristic h_{sa} (ctd.)

Computing annotations:

- ... (Effect nodes for unconditional effects are represented just by the operator, without a condition.)

Termination criterion:

- **stability**: terminate if set for proposition node a^k has same cardinality as for a^{k-1} for all true propositions a in layer k (and true propositions in layers k and $k - 1$ are the same)

Heuristic value:

- The heuristic value is the **set cardinality** of the goal node annotation.

Parallel plans

Relaxed planning graphs

Relaxation heuristics

Generic template

h_{max}

h_{add}

h_{sa}

Incremental computation

h_{FF}

Comparison & practice

Summary

Running example: h_{sa}

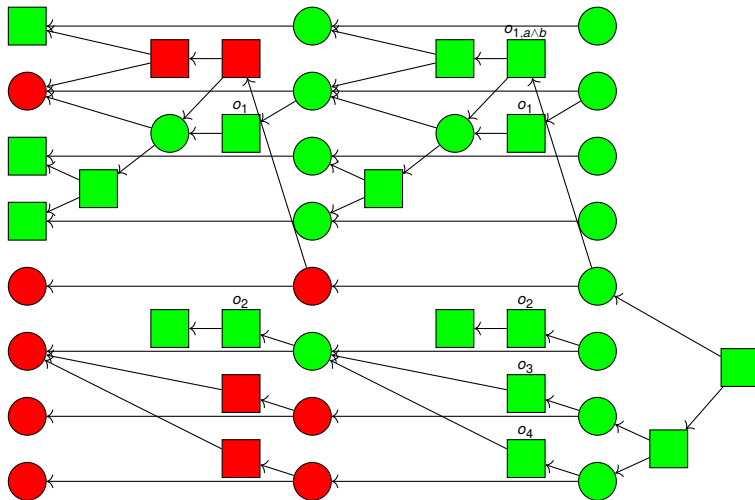

Parallel plans

Relaxed planning graphs

Relaxation heuristics

Generic template

h_{max}

h_{add}

h_{sa}

Incremental computation

h_{FF}

Comparison & practice

Summary

Running example: h_{sa}

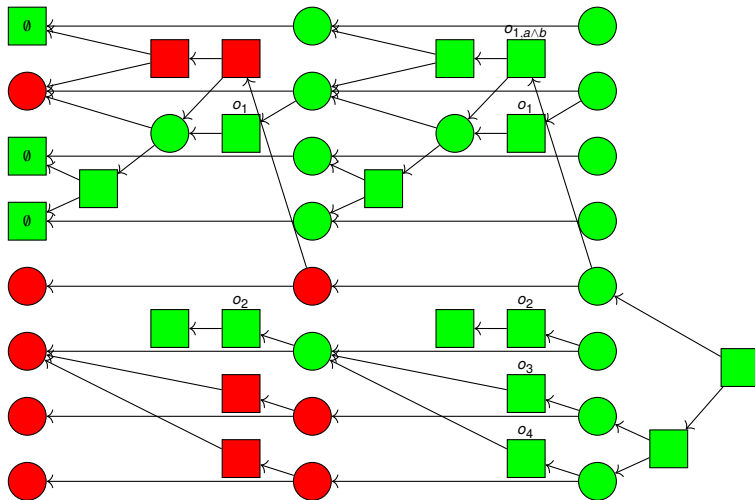

Parallel plans

Relaxed planning graphs

Relaxation heuristics

Generic template

h_{max}

h_{add}

h_{sa}

Incremental computation

h_{FF}

Comparison & practice

Summary

Running example: h_{sa}

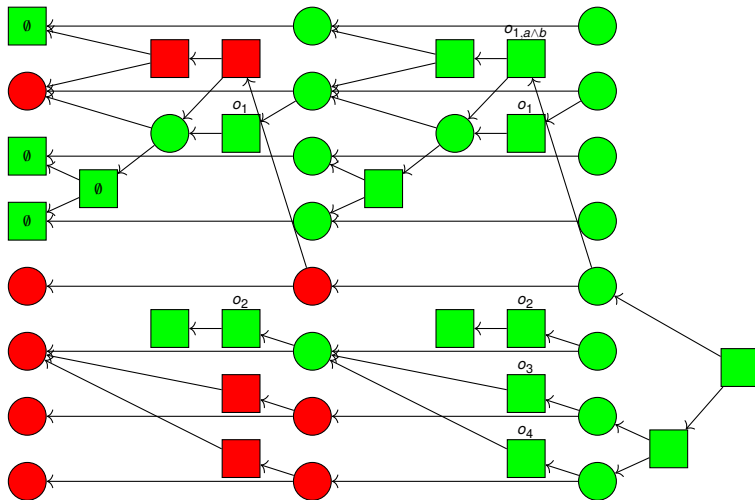

Parallel plans

Relaxed planning graphs

Relaxation heuristics

Generic template

h_{max}

h_{add}

h_{sa}

Incremental computation

h_{FF}

Comparison & practice

Summary

Running example: h_{sa}

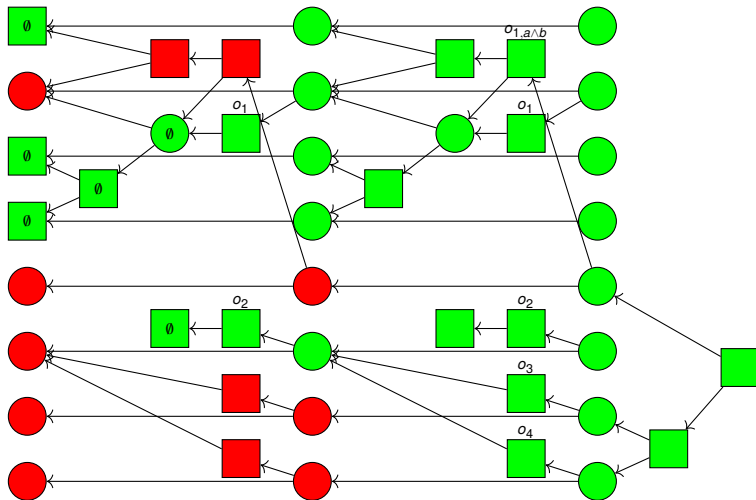

Parallel plans

Relaxed planning graphs

Relaxation heuristics

Generic template

h_{max}

h_{add}

h_{sa}

Incremental computation

h_{FF}

Comparison & practice

Summary

Running example: h_{sa}

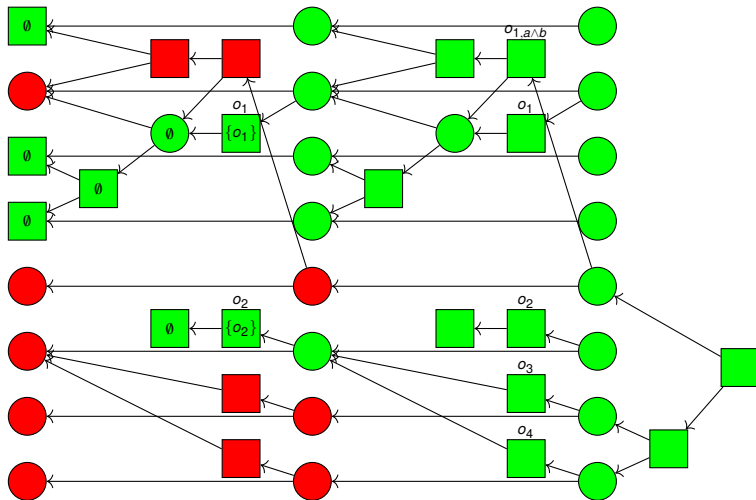

Parallel plans

Relaxed planning graphs

Relaxation heuristics

Generic template

h_{max}

h_{add}

h_{sa}

Incremental computation

h_{FF}

Comparison & practice

Summary

Running example: h_{sa}

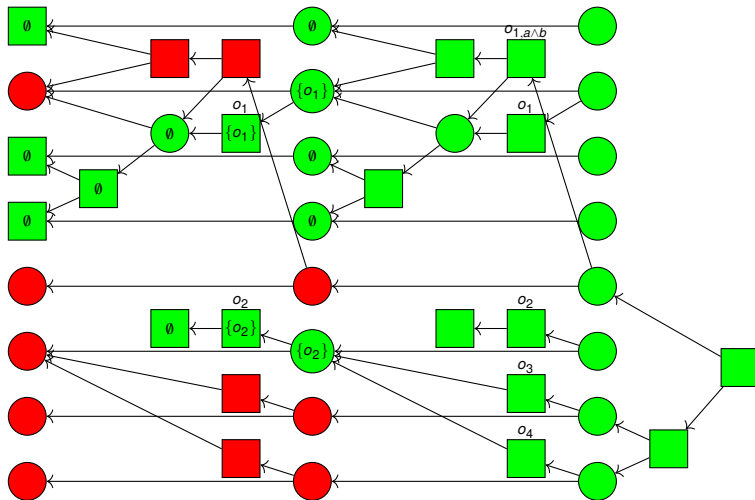

Parallel plans

Relaxed planning graphs

Relaxation heuristics

Generic template

h_{max}

h_{add}

h_{sa}

Incremental computation

h_{FF}

Comparison & practice

Summary

Running example: h_{sa}

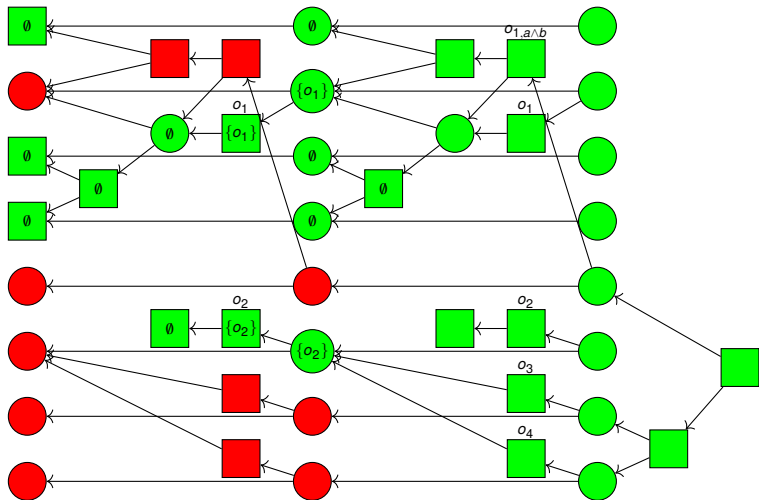

Parallel plans

Relaxed planning graphs

Relaxation heuristics

Generic template

h_{max}

h_{add}

h_{sa}

Incremental computation

h_{FF}

Comparison & practice

Summary

Running example: h_{sa}

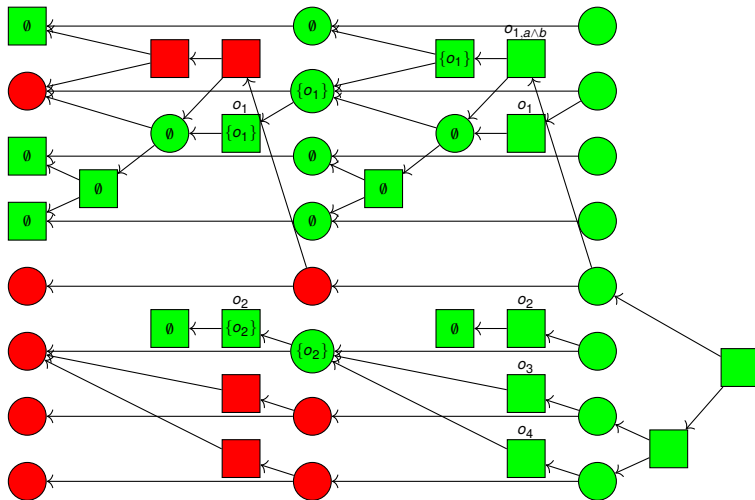

Parallel plans

Relaxed planning graphs

Relaxation heuristics

Generic template

h_{max}

h_{add}

h_{sa}

Incremental computation

h_{FF}

Comparison & practice

Summary

Running example: h_{sa}

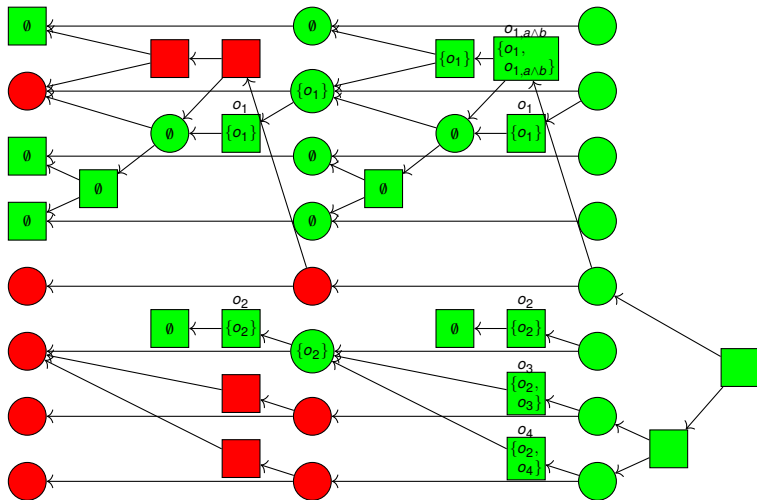

Parallel plans

Relaxed planning graphs

Relaxation heuristics

Generic template

h_{max}

h_{add}

h_{sa}

Incremental computation

h_{FF}

Comparison & practice

Summary

Running example: h_{sa}

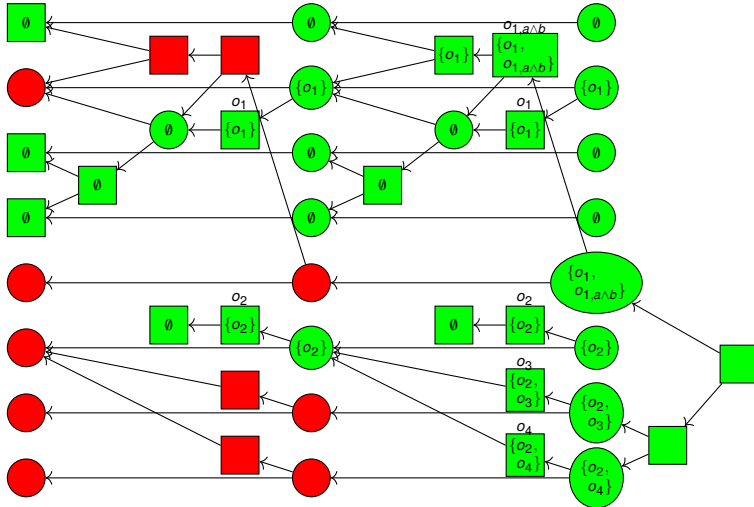

Parallel plans

Relaxed planning graphs

Relaxation heuristics

Generic template

h_{max}

h_{add}

h_{sa}

Incremental computation

h_{FF}

Comparison & practice

Summary

Running example: h_{sa}

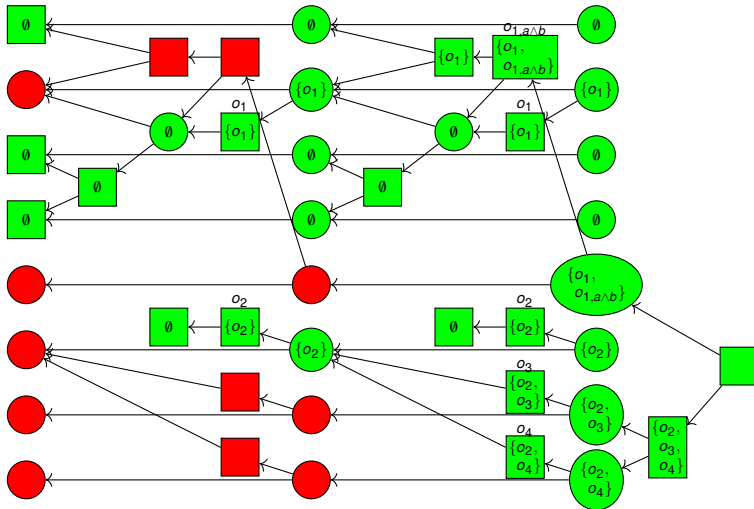

Parallel plans

Relaxed planning graphs

Relaxation heuristics

Generic template

h_{max}

h_{add}

h_{sa}

Incremental computation

h_{FF}

Comparison & practice

Summary

Running example: h_{sa}

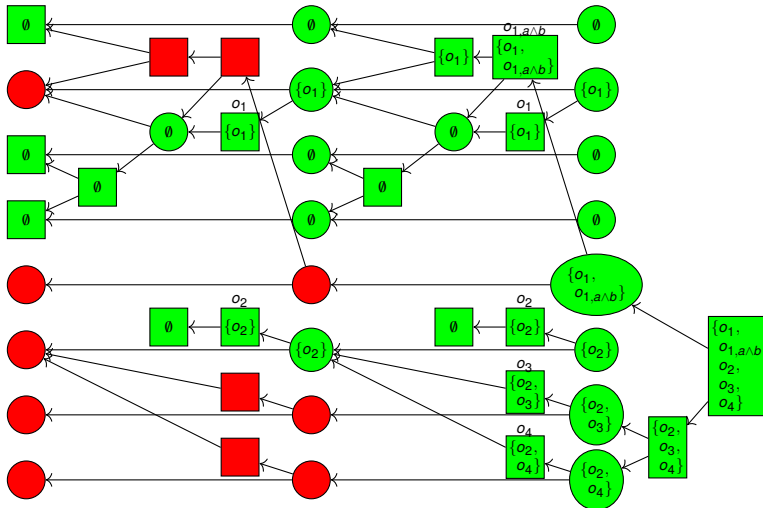

Parallel plans

Relaxed planning graphs

Relaxation heuristics

Generic template

h_{max}

h_{add}

h_{sa}

Incremental computation

h_{FF}

Comparison & practice

Summary



- The same remarks for stability as for h_{add} apply.
- Like h_{add} , h_{sa} is **safe** and **goal-aware**, but neither **admissible** nor **consistent**.
- h_{sa} is generally **better informed** than h_{add} , but significantly more expensive to compute.
- The h_{sa} value depends on the tie-breaking rule used, so h_{sa} is **not well-defined** without specifying the tie-breaking rule.
- The operators contained in the goal node annotation, suitably ordered, define a **relaxed plan** for the task.
 - Operators mentioned several times in the annotation must be added as many times in the relaxed plan.

Parallel plans

Relaxed planning graphs

Relaxation heuristics

Generic template

h_{max}

h_{add}

h_{sa}

Incremental computation

h_{FF}

Comparison & practice

Summary



One nice property of forward-propagating heuristics is that they allow **incremental computation**:

- when evaluating several states in sequence which only differ in a few state variables, can
 - **start computation from previous results** and
 - keep track only of **what needs to be recomputed**
- typical use case: **depth-first** style searches (e. g., IDA*)
- rarely exploited in practice

Parallel plans

Relaxed planning graphs

Relaxation heuristics

Generic template

h_{max}

h_{add}

h_{sa}

Incremental computation

h_{FF}

Comparison & practice

Summary

Incremental computation example: h_{add}



Result for $\{a \mapsto 1, b \mapsto 0, c \mapsto 1, d \mapsto 1, e \mapsto 0, f \mapsto 0, g \mapsto 0, h \mapsto 0\}$

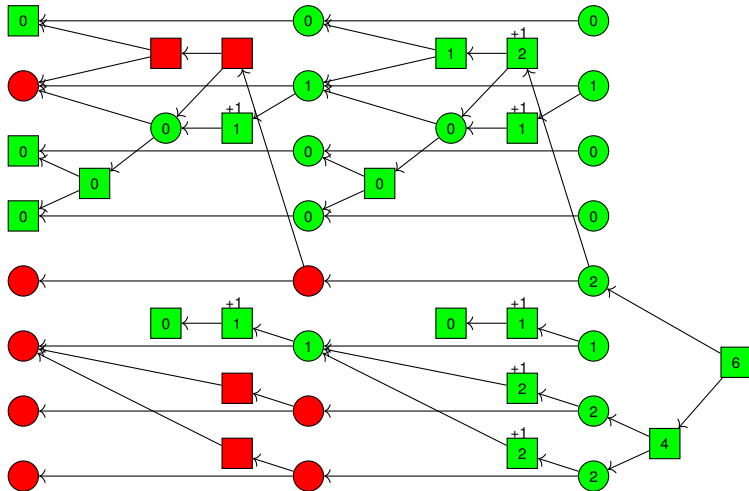

Parallel plans

Relaxed planning graphs

Relaxation heuristics

Generic template

h_{max}

h_{add}

h_{sa}

Incremental computation

h_{FF}

Comparison & practice

Summary

Incremental computation example: h_{add}



Change value of e to 1.

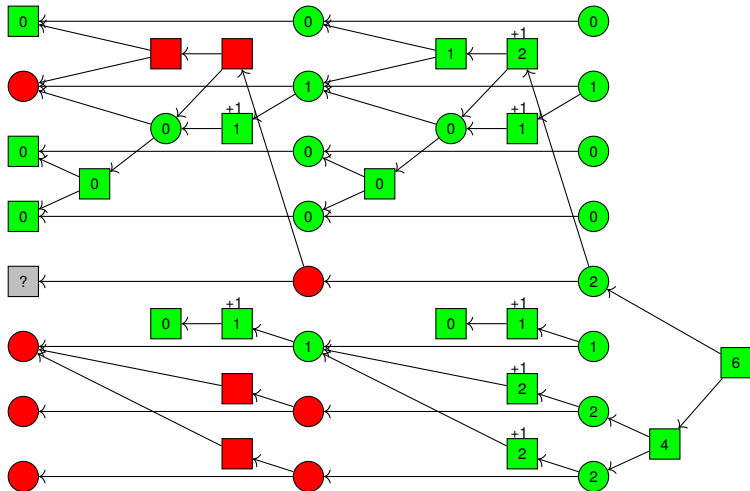

Parallel plans

Relaxed planning graphs

Relaxation heuristics

Generic template

h_{max}

h_{add}

h_{sa}

Incremental computation

h_{FF}

Comparison & practice

Summary

Incremental computation example: h_{add}



Recompute outdated values.

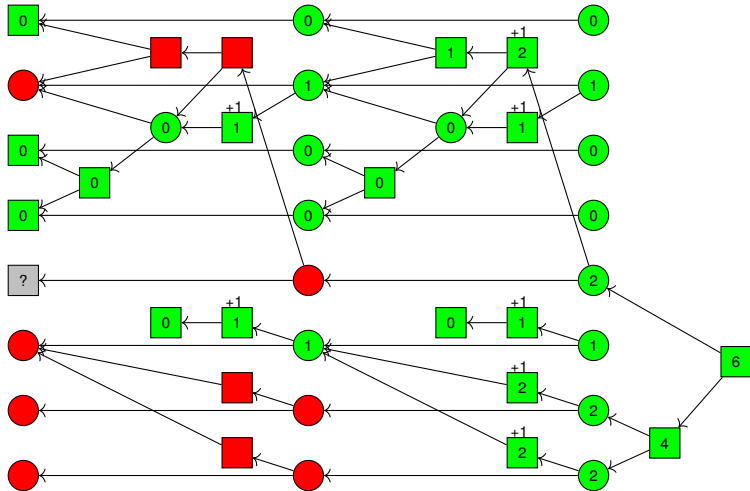

Parallel plans

Relaxed planning graphs

Relaxation heuristics

Generic template

h_{max}

h_{add}

h_{sa}

Incremental computation

h_{FF}

Comparison & practice

Summary

Incremental computation example: h_{add}



Recompute outdated values.

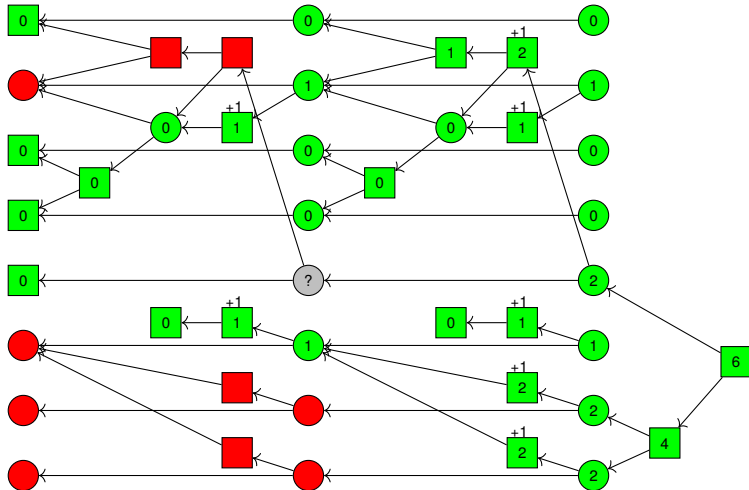

Parallel plans

Relaxed planning graphs

Relaxation heuristics

Generic template

h_{max}

h_{add}

h_{sa}

Incremental computation

h_{FF}

Comparison & practice

Summary

Incremental computation example: h_{add}



Recompute outdated values.

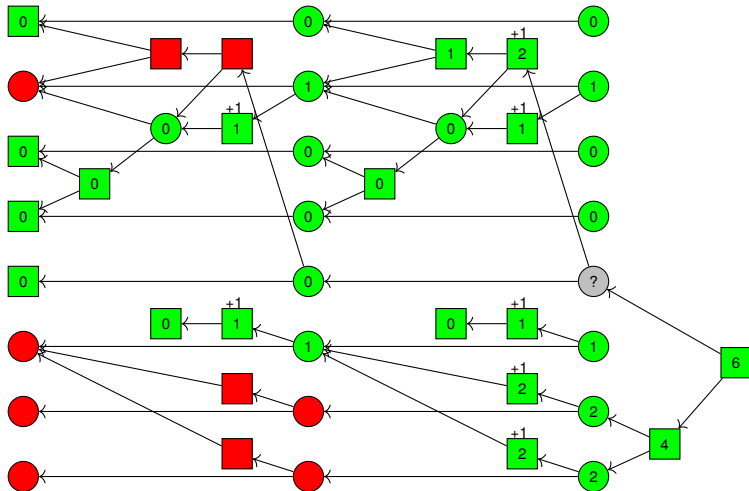

Parallel plans

Relaxed planning graphs

Relaxation heuristics

Generic template

h_{max}

h_{add}

h_{sa}

Incremental computation

h_{FF}

Comparison & practice

Summary

Incremental computation example: h_{add}



Recompute outdated values.

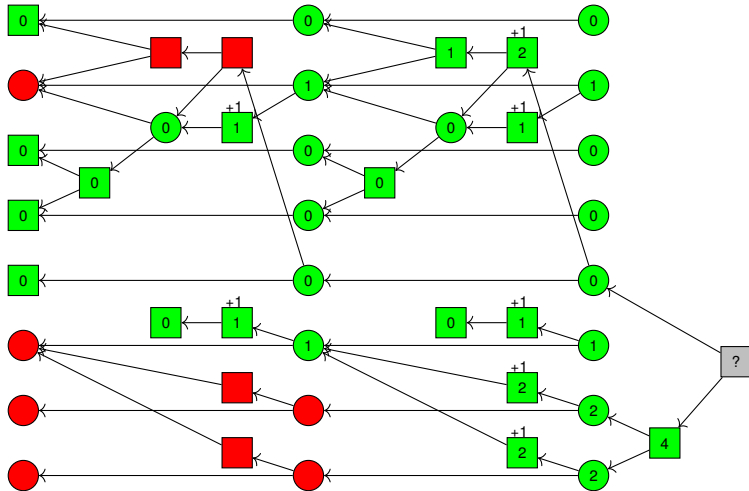

Parallel plans

Relaxed planning graphs

Relaxation heuristics

Generic template

h_{max}

h_{add}

h_{sa}

Incremental computation

h_{FF}

Comparison & practice

Summary

Incremental computation example: h_{add}



Recompute outdated values.

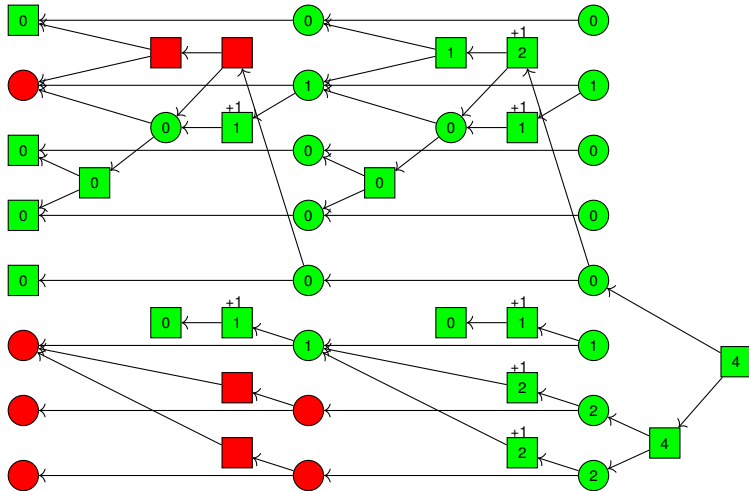

Parallel plans

Relaxed planning graphs

Relaxation heuristics

Generic template

h_{max}

h_{add}

h_{sa}

Incremental computation

h_{FF}

Comparison & practice

Summary



- h_{sa} is more expensive to compute than the other forward propagating heuristics because we must propagate **sets**.
- It is possible to get the same advantage over h_{add} combined with efficient propagation.
- Key idea of h_{FF} : perform a **backward propagation** that selects a sufficient subset of nodes to make the goal true (called a **solution graph** in AND/OR dag literature).
- The resulting heuristic is almost as informative as h_{sa} , yet computable as quickly as h_{add} .

Note: Our presentation inverts the historical order. The set-additive heuristic was defined **after** the FF heuristic (sacrificing speed for even higher informativeness).

Parallel plans

Relaxed planning graphs

Relaxation heuristics

Generic template

h_{max}

h_{add}

h_{sa}

Incremental computation

h_{FF}

Comparison & practice

Summary



The FF heuristic h_{FF}

Computing annotations:

- Annotations are **Boolean values**, computed top-down. A node is **marked** when its annotation is set to 1 and **unmarked** if it is set to 0. Initially, the goal node is marked, and all other nodes are unmarked.

We say that a true AND node is **justified** if all its true successors are marked, and that a true OR node is **justified** if at least one of its true successors is marked.

...

Parallel plans

Relaxed planning graphs

Relaxation heuristics

Generic template

h_{max}

h_{add}

h_{sa}

Incremental computation

h_{FF}

Comparison & practice

Summary



The FF heuristic h_{FF} (ctd.)

Computing annotations:

■ ...

Apply these rules until **all marked nodes are justified**:

- 1 Mark all true successors of a marked unjustified AND node.
- 2 Mark the true successor of a marked unjustified OR node with only one true successor.
- 3 Mark a true successor of a marked unjustified OR node connected via an idle arc.
- 4 Mark any true successor of a marked unjustified OR node.

The rules are given in priority order: earlier rules are preferred if applicable.

Parallel plans

Relaxed planning graphs

Relaxation heuristics

Generic template

h_{max}

h_{add}

h_{sa}

Incremental computation

h_{FF}

Comparison & practice

Summary



The FF heuristic h_{FF} (ctd.)

Termination criterion:

- **Always terminate** at first layer where goal node is true.

Heuristic value:

- The heuristic value is the **number of operator/effect condition pairs** for which **at least one** effect node is marked.

Parallel plans

Relaxed planning graphs

Relaxation heuristics

Generic template

h_{max}

h_{add}

h_{sa}

Incremental computation

h_{FF}

Comparison & practice

Summary

Running example: h_{FF}

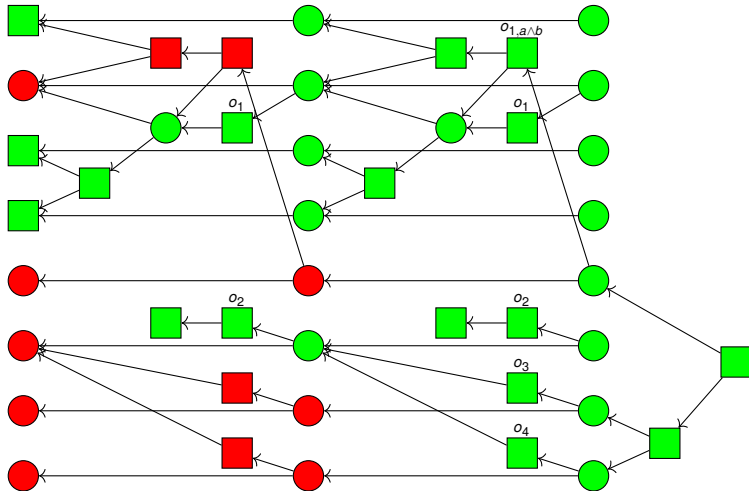

Parallel plans

Relaxed planning graphs

Relaxation heuristics

Generic template

h_{max}

h_{add}

h_{sa}

Incremental computation

h_{FF}

Comparison & practice

Summary

Running example: h_{FF}

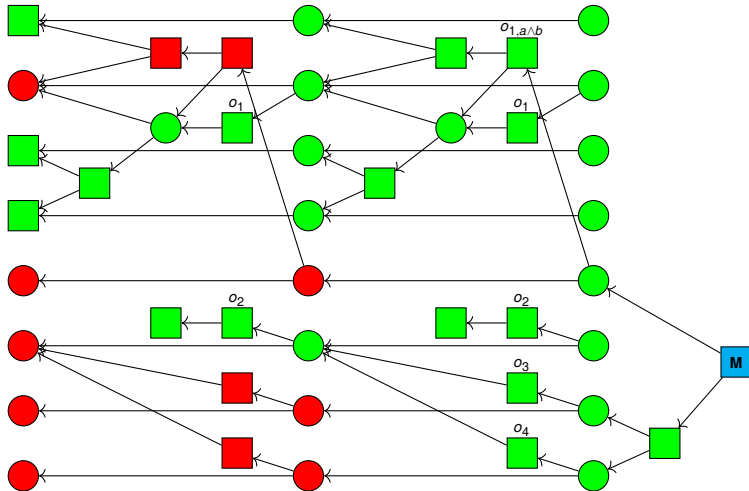

Parallel plans

Relaxed planning graphs

Relaxation heuristics

Generic template

h_{max}

h_{add}

h_{sa}

Incremental computation

h_{FF}

Comparison & practice

Summary

Running example: h_{FF}

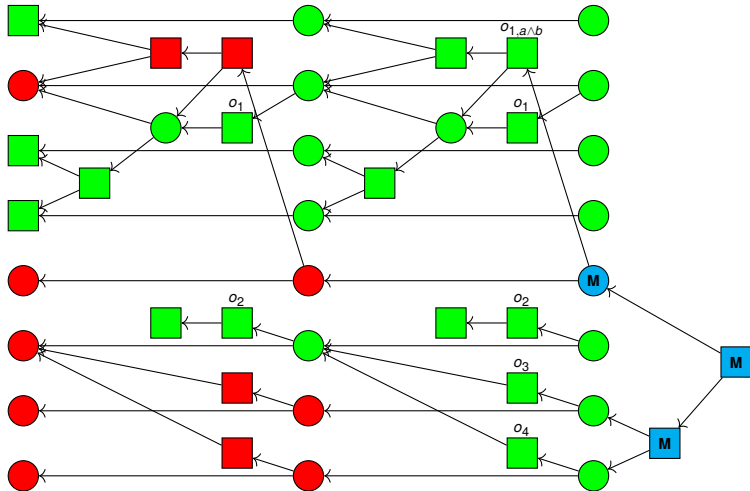

Parallel plans

Relaxed planning graphs

Relaxation heuristics

Generic template

h_{max}

h_{add}

h_{sa}

Incremental computation

h_{FF}

Comparison & practice

Summary

Running example: h_{FF}

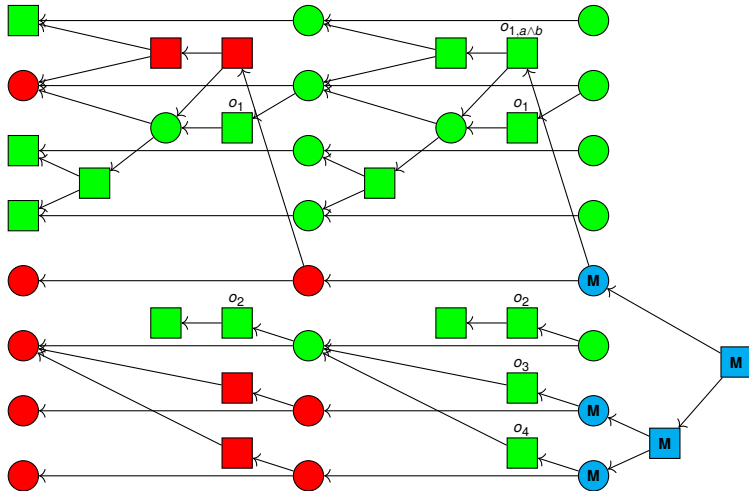

Parallel plans

Relaxed planning graphs

Relaxation heuristics

Generic template

h_{max}

h_{add}

h_{sa}

Incremental computation

h_{FF}

Comparison & practice

Summary

Running example: h_{FF}

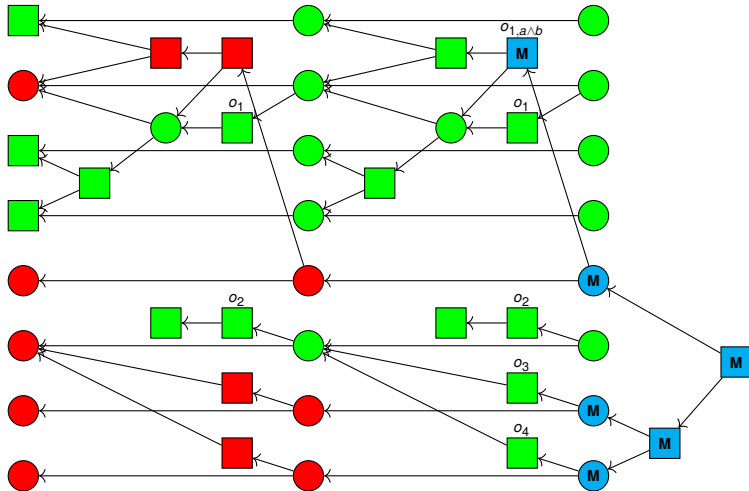

Parallel plans

Relaxed planning graphs

Relaxation heuristics

Generic template

h_{max}

h_{add}

h_{sa}

Incremental computation

h_{FF}

Comparison & practice

Summary

Running example: h_{FF}

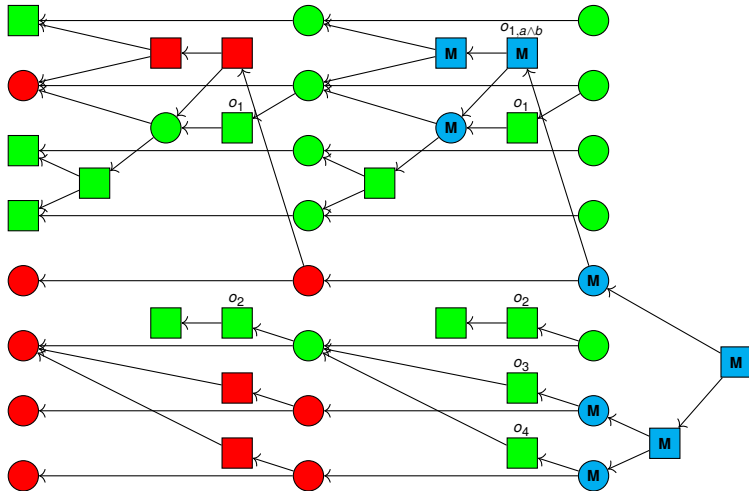

Parallel plans

Relaxed planning graphs

Relaxation heuristics

Generic template

h_{max}

h_{add}

h_{sa}

Incremental computation

h_{FF}

Comparison & practice

Summary

Running example: h_{FF}

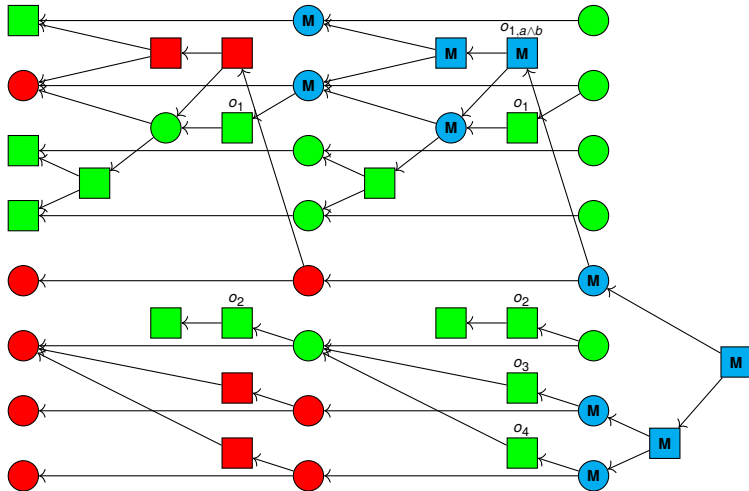

Parallel plans

Relaxed planning graphs

Relaxation heuristics

Generic template

h_{max}

h_{add}

h_{sa}

Incremental computation

h_{FF}

Comparison & practice

Summary

Running example: h_{FF}

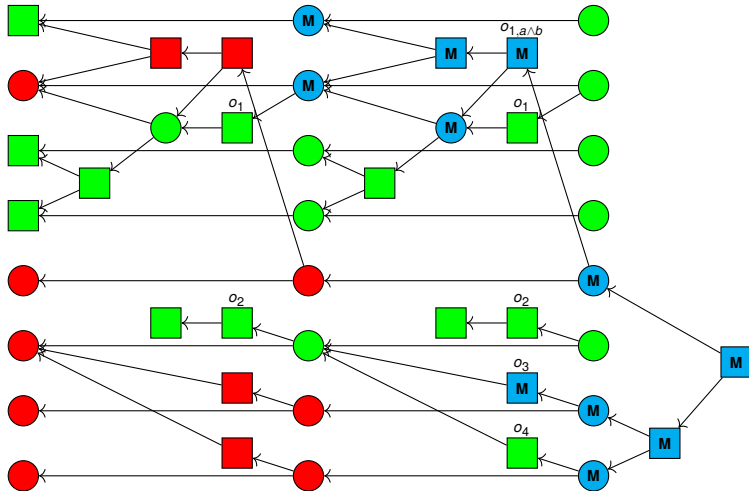

Parallel plans

Relaxed planning graphs

Relaxation heuristics

Generic template

h_{max}

h_{add}

h_{sa}

Incremental computation

h_{FF}

Comparison & practice

Summary

Running example: h_{FF}

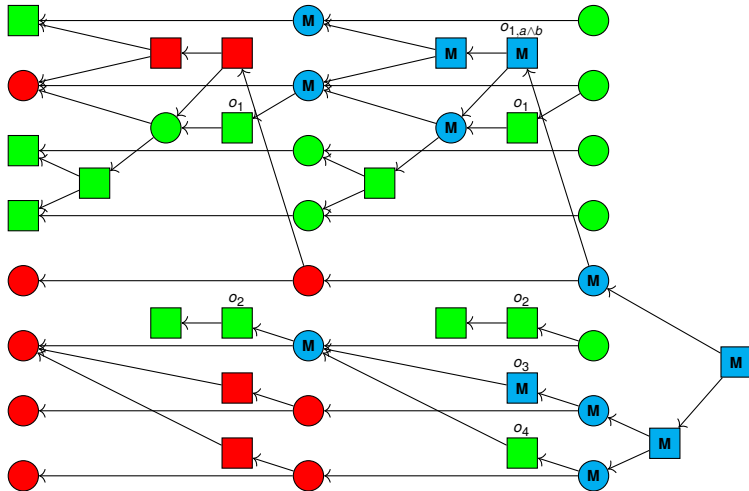

Parallel plans

Relaxed planning graphs

Relaxation heuristics

Generic template

h_{max}

h_{add}

h_{sa}

Incremental computation

h_{FF}

Comparison & practice

Summary

Running example: h_{FF}

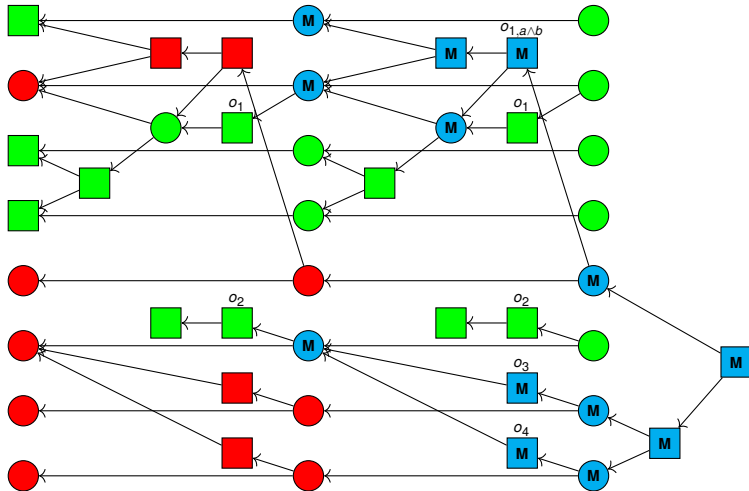

Parallel plans

Relaxed planning graphs

Relaxation heuristics

Generic template

h_{max}

h_{add}

h_{sa}

Incremental computation

h_{FF}

Comparison & practice

Summary

Running example: h_{FF}

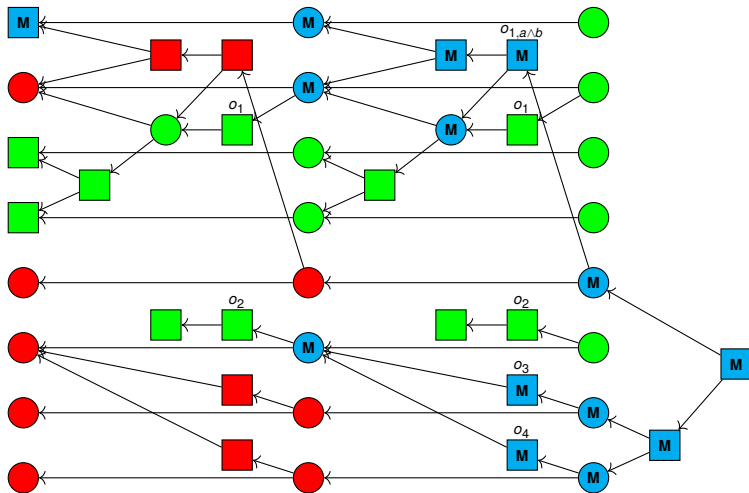

Parallel plans

Relaxed planning graphs

Relaxation heuristics

Generic template

h_{max}

h_{add}

h_{sa}

Incremental computation

h_{FF}

Comparison & practice

Summary

Running example: h_{FF}

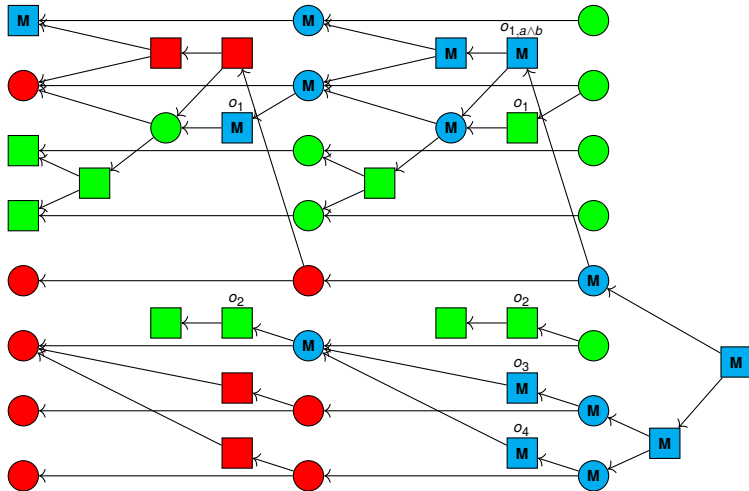

Parallel plans

Relaxed planning graphs

Relaxation heuristics

Generic template

h_{max}

h_{add}

h_{sa}

Incremental computation

h_{FF}

Comparison & practice

Summary

Running example: h_{FF}

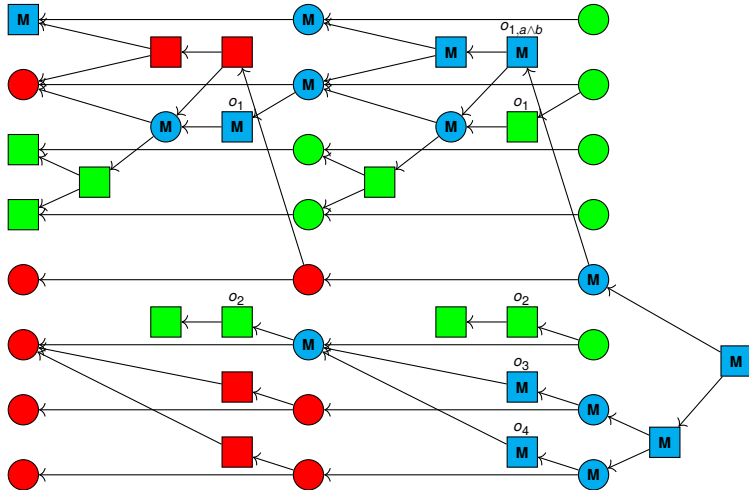

Parallel plans

Relaxed planning graphs

Relaxation heuristics

Generic template

h_{max}

h_{add}

h_{sa}

Incremental computation

h_{FF}

Comparison & practice

Summary

Running example: h_{FF}

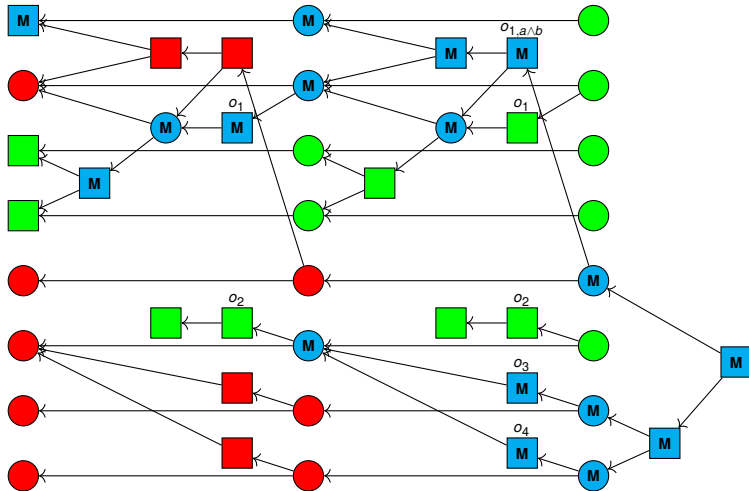

Parallel plans

Relaxed planning graphs

Relaxation heuristics

Generic template

h_{max}

h_{add}

h_{sa}

Incremental computation

h_{FF}

Comparison & practice

Summary

Running example: h_{FF}

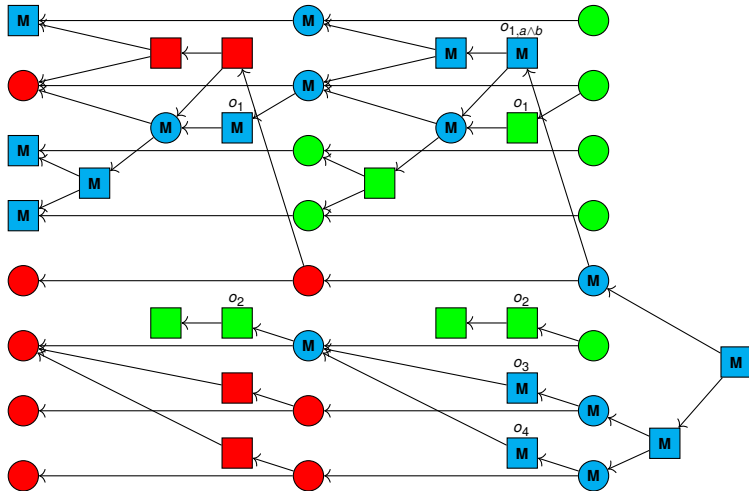

Parallel plans

Relaxed planning graphs

Relaxation heuristics

Generic template

h_{max}

h_{add}

h_{sa}

Incremental computation

h_{FF}

Comparison & practice

Summary

Running example: h_{FF}

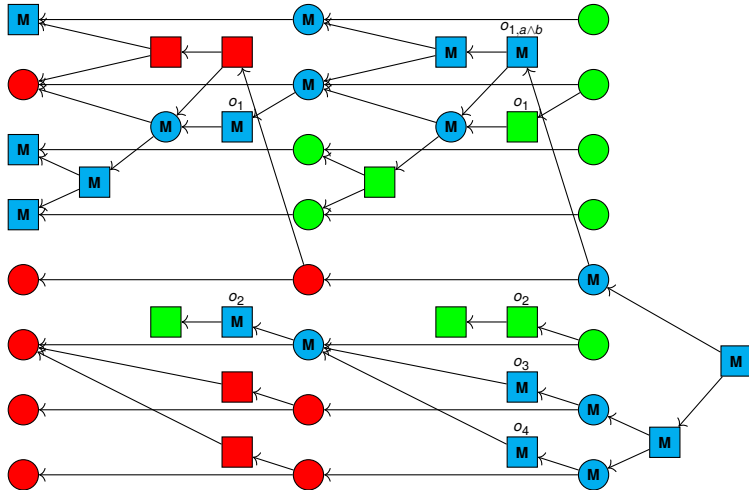

Parallel plans

Relaxed planning graphs

Relaxation heuristics

Generic template

h_{max}

h_{add}

h_{sa}

Incremental computation

h_{FF}

Comparison & practice

Summary

Running example: h_{FF}

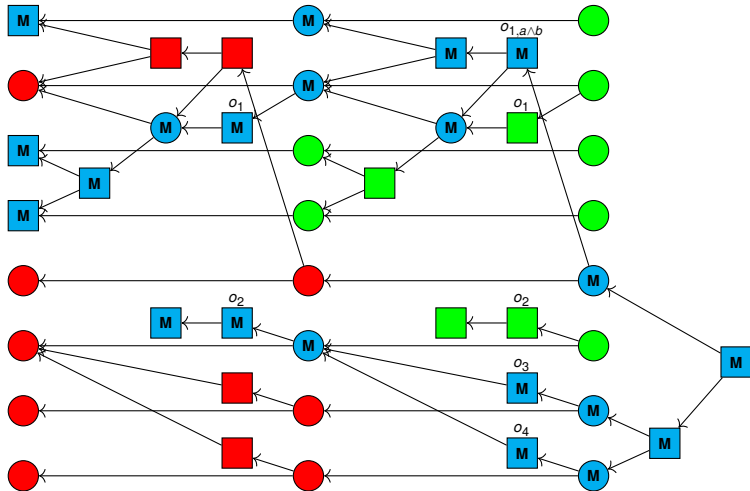

Parallel plans

Relaxed planning graphs

Relaxation heuristics

Generic template

h_{max}

h_{add}

h_{sa}

Incremental computation

h_{FF}

Comparison & practice

Summary



- Like h_{add} and h_{sa} , h_{FF} is **safe** and **goal-aware**, but neither **admissible** nor **consistent**.
- Its informativeness can be expected to be slightly worse than for h_{sa} , but is usually not far off.
- Unlike h_{sa} , h_{FF} can be computed in **linear time**.
- Similar to h_{sa} , the operators corresponding to the marked operator/effect condition pairs define a **relaxed plan**.
- Similar to h_{sa} , the h_{FF} value depends on tie-breaking when the marking rules allow several possible choices, so h_{FF} is **not well-defined** without specifying the tie-breaking rule.
 - The implementation in FF uses additional rules of thumb to try to reduce the size of the generated relaxed plan.

Parallel plans

Relaxed planning graphs

Relaxation heuristics

Generic template

h_{max}

h_{add}

h_{sa}

Incremental computation

h_{FF}

Comparison & practice

Summary

Theorem (relationship between relaxation heuristics)

Let s be a state of planning task $\langle A, I, O, \gamma \rangle$. Then:

- $h_{max}(s) \leq h^+(s) \leq h^*(s)$
- $h_{max}(s) \leq h^+(s) \leq h_{sa}(s) \leq h_{add}(s)$
- $h_{max}(s) \leq h^+(s) \leq h_{FF}(s) \leq h_{add}(s)$
- h^* , h_{FF} and h_{sa} are pairwise incomparable
- h^* and h_{add} are incomparable

Moreover, h^+ , h_{max} , h_{add} , h_{sa} and h_{FF} assign ∞ to the same set of states.

Note: For **inadmissible** heuristics, dominance is in general neither desirable nor undesirable. For relaxation heuristics, the objective is usually to get as close to h^+ as possible.

Parallel plans

Relaxed planning graphs

Relaxation heuristics

Generic template

h_{max}

h_{add}

h_{sa}

Incremental computation

h_{FF}

Comparison & practice

Summary



Example (HSP)

HSP (Bonet & Geffner) was one of the four top performers at the 1st International Planning Competition (IPC-1998).

Key ideas:

- **hill climbing** search using h_{add}
- on **plateaus**, keep going for a number of iterations, then restart
- use a closed list during exploration of plateaus

Literature: Bonet, Loerincs & Geffner (1997), Bonet & Geffner (2001)

Parallel plans

Relaxed planning graphs

Relaxation heuristics

Generic template

h_{max}

h_{add}

h_{sa}

Incremental computation

h_{FF}

Comparison & practice

Summary



Example (FF)

FF (Hoffmann & Nebel) won the 2nd International Planning Competition (IPC-2000).

Key ideas:

- **enforced hill-climbing** search using h_{FF}
- **helpful action pruning**: in each search node, only consider successors from operators that add one of the atoms marked in proposition layer 1
- **goal ordering**: in certain cases, FF recognizes and exploits that certain subgoals should be solved one after the other

If main search fails, FF performs greedy best-first search using h_{FF} without helpful action pruning or goal ordering.

Parallel plans

Relaxed planning graphs

Relaxation heuristics

Generic template

h_{max}

h_{add}

h_{sa}

Incremental computation

h_{FF}

Comparison & practice

Summary

Relaxation heuristics in practice: Fast Downward



Example (Fast Downward)

Fast Downward (Helmert & Richter) won the satisficing track of the 4th International Planning Competition (IPC-2004).

Key ideas:

- **greedy best-first search** using h_{FF} and **causal graph heuristic** (not relaxation-based)
- search enhancements:
 - multi-heuristic best-first search
 - deferred evaluation of heuristic estimates
 - preferred operators (similar to FF's helpful actions)

Literature: Helmert (2006)

Parallel plans

Relaxed planning graphs

Relaxation heuristics

Generic template

h_{max}

h_{add}

h_{ca}

Incremental computation

h_{FF}

Comparison & practice

Summary



Example (SGPlan)

SGPlan (Wah, Hsu, Chen & Huang) won the satisficing track of the 5th International Planning Competition (IPC-2006).

Key ideas:

- **FF**
- **problem decomposition** techniques
- **domain-specific techniques**

Literature: Chen, Wah & Hsu (2006)

Parallel plans

Relaxed planning graphs

Relaxation heuristics

Generic template

h_{max}

h_{add}

h_{sa}

Incremental computation

h_{FF}

Comparison & practice

Summary



Example (LAMA)

LAMA (Richter & Westphal) won the satisficing track of the 6th International Planning Competition (IPC-2008).

Key ideas:

- **Fast Downward**
- **landmark pseudo-heuristic** instead of causal graph heuristic (“somewhat” relaxation-based)
- anytime variant of **Weighted A*** instead of greedy best-first search

Literature: Richter, Helmert & Westphal (2008),
Richter & Westphal (2010)

Parallel
plans

Relaxed
planning
graphs

Relaxation
heuristics

Generic template

h_{max}

h_{add}

h_{sa}

Incremental
computation

h_{FF}

Comparison &
practice

Summary



- **Relaxed planning graphs** are **AND/OR dags**. They encode which propositions can be made true in Π^+ and how.
 - Closely related to **forward sets** and **forward plan steps**, based on the notion of **parallel relaxed plans**.
 - They can be **constructed and evaluated efficiently**, in time $O((m+1) \|\Pi^+\|)$ for planning task Π and depth m .
- By annotating RPG nodes with appropriate information, we can compute many useful heuristics.
- Examples: **max** heuristic h_{\max} , **additive** heuristic h_{add} , **set-additive** heuristic h_{sa} and **FF** heuristic h_{FF}
 - Of these, only h_{\max} admissible (but not very accurate).
 - The others are much more informative. The set-additive heuristic is the most sophisticated one.
 - The FF heuristic is often similarly informative. It offers a good trade-off between accuracy and computation time.

Parallel plans

Relaxed planning graphs

Relaxation heuristics

Summary